

Mesures or expressed in:
 mm □ cm □ m □ in □ ft □

Rev.N	Revision note	Date	Signature

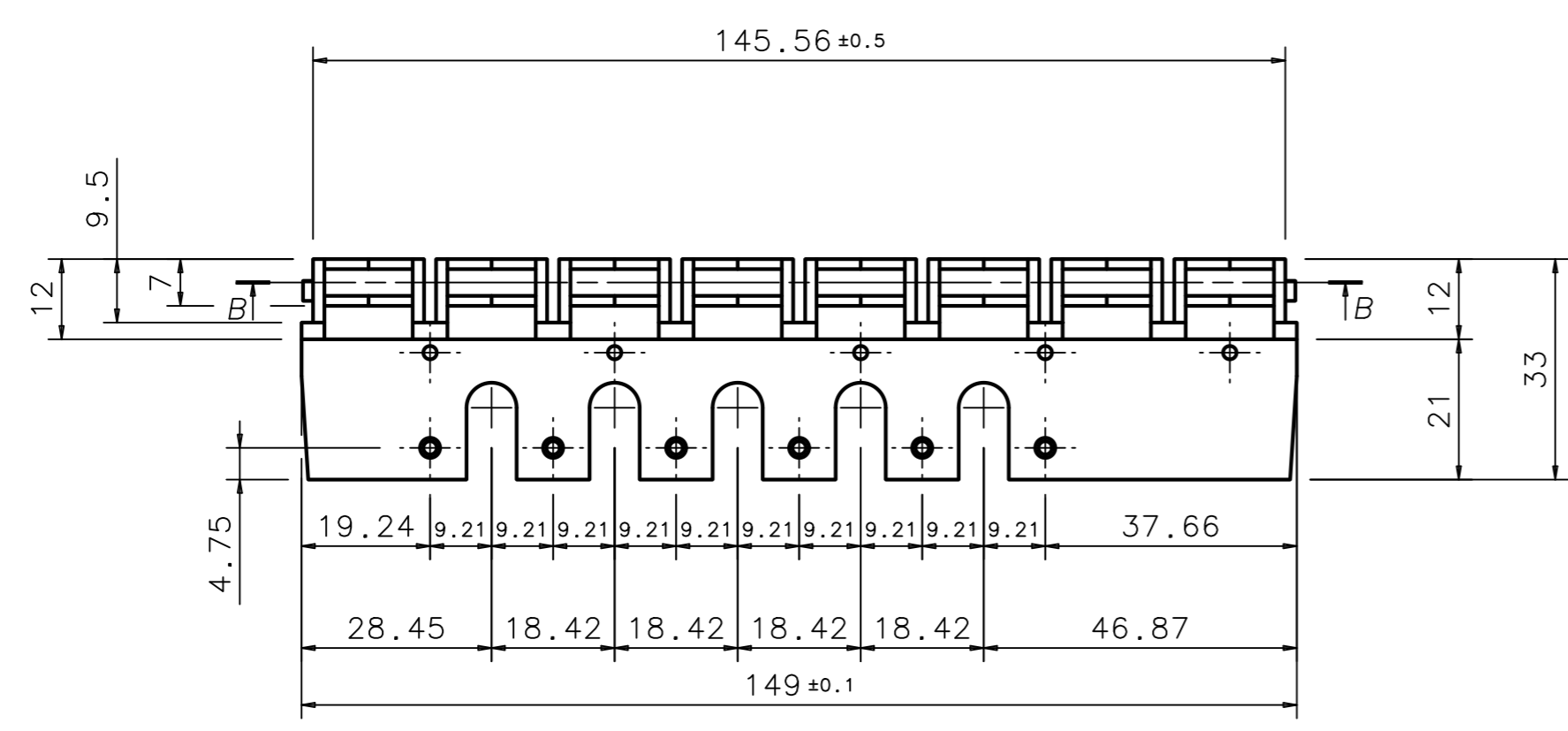
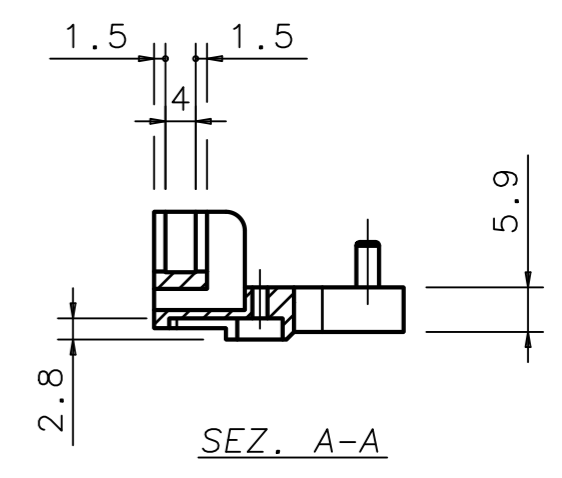
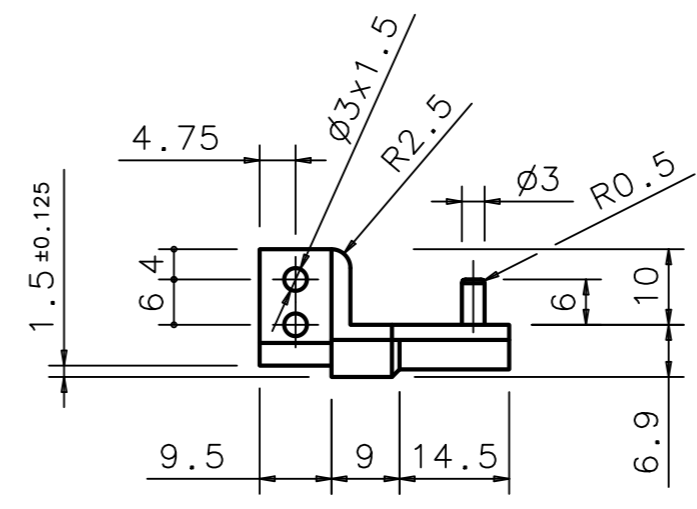
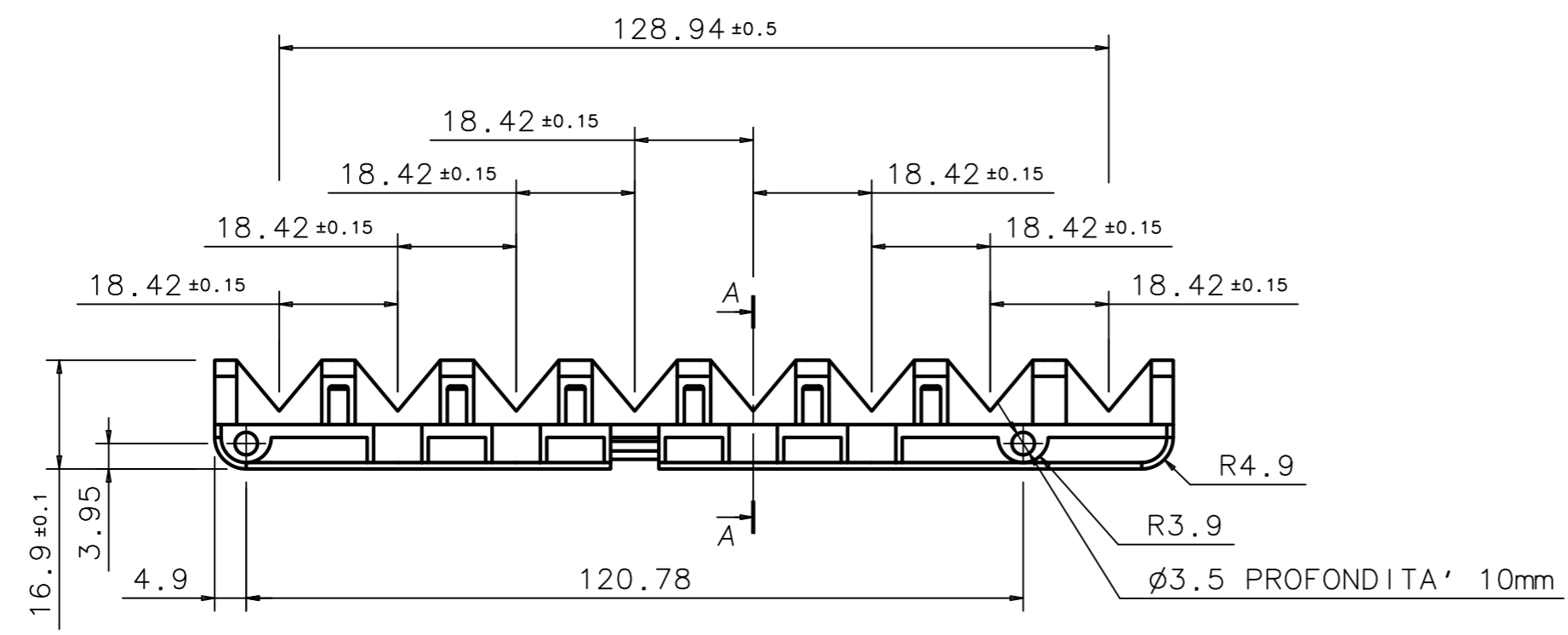
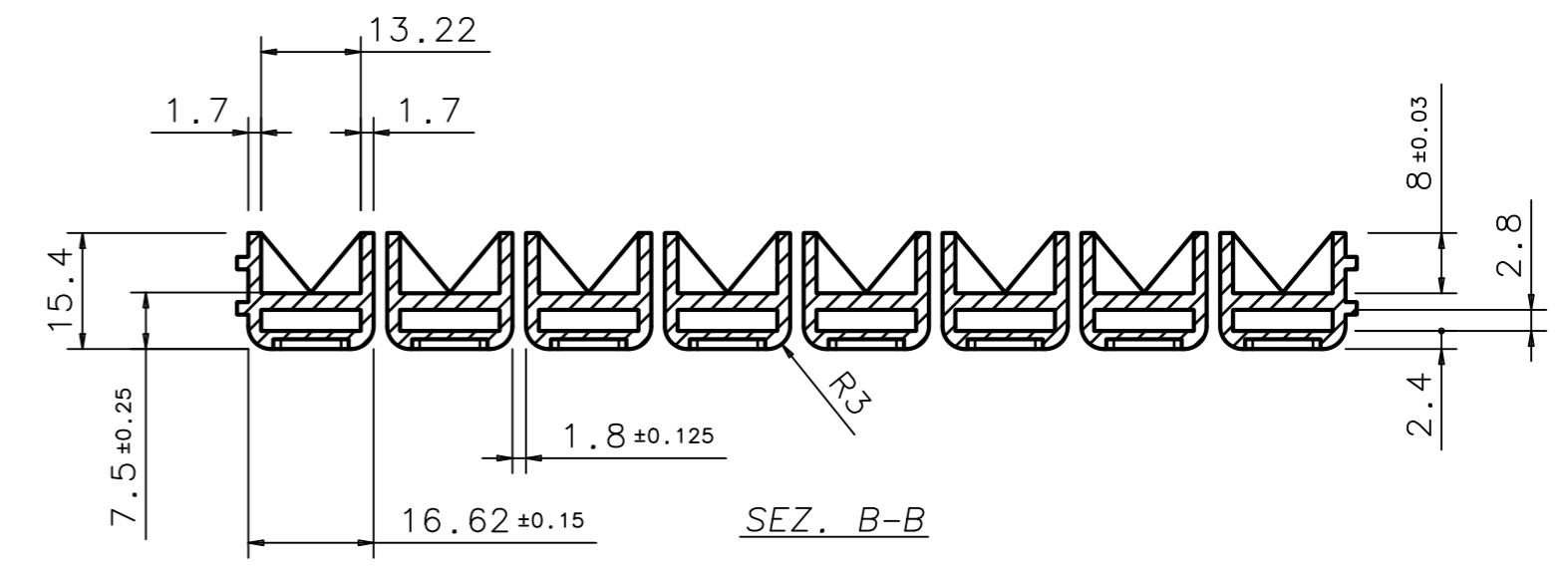
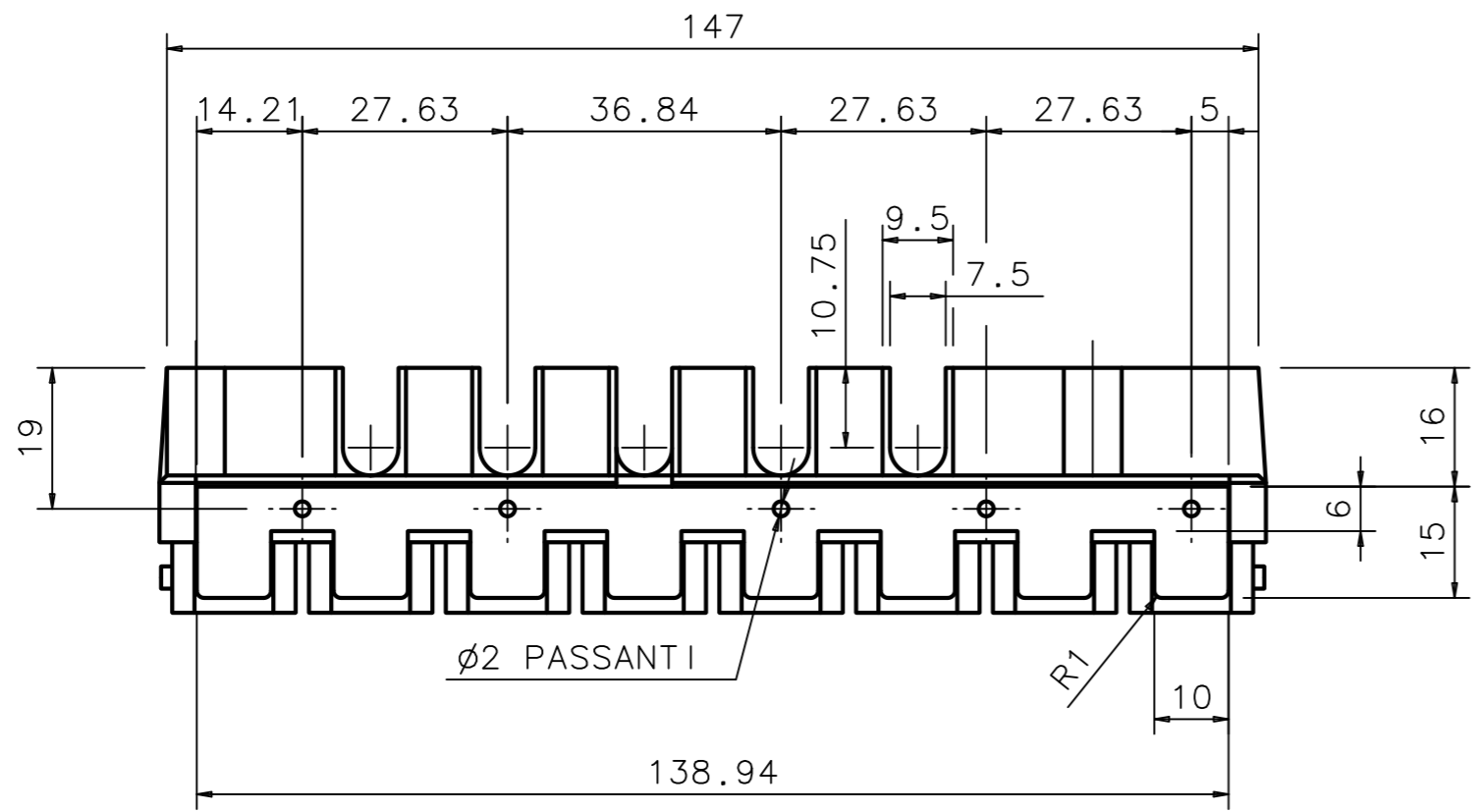

PART N.		DRAWING		MATERIAL		PORTABASETTE 8 CELLE		DENOMINATION		Q.TY	
Gen. Tol. for untoleranced dimensions: ISO 2768-mk-E				Geometrical tolerances: ISO 8015 - E				Roughness: ISO 1302			
		Istituto Nazionale di Fisica Nucleare Sezione di Ferrara				Designer FEDERICO EVANGELISTI		Via Scienze, 39 44100 - Ferrara Tel 0532974296 e-mail: evangelisti@fe.infn.it			
BaBar		Experiment/Project		Scale 1:1		Date 25/09/03		Document no. BABAR/PO-001MOD			
PORTABASETTE		Size A2		Sheet		File		PO001MOD.pdf			