

# CSN 1

Riunione del 28 settembre - 2 ottobre

CdS

14/10/2020

Stefano Lacaprara

INFN Padova

# Bilancio 2020: avanzi e tascona

- Avanzi missioni 2020 sigle: 4617kE (su 8000keu assegnati)
  - ½ a GE
  - ½ per anticipi di spese 2021: 2308.5 keu:
    - MOF-A CMS+ATLAS
    - Resto per anticipi SF
- Avanzi non missioni: 330.5 keu
  - Anticipi similfellow 2021
    - 533 keu
    - BES III - 60 keu RISE
    - +altro
      - Tra cui 10keu MuCol per computing a PD
        - Assegnati a Dtz gr1
        - Da capire se Tier2 o Cloud
- La ½ che rimane in CSN1 in “Tascona” per il 2021

# Bilancio 2021



- Previsione di bilancio “come se fosse un anno normale”
  - Totale 8Meu (missioni) + 12Meu (resto) = 20 Meu
- Ma 2308.5keu in “Tascona” da tenere a parte
  - Sara’ assegnata (in tutto o in parte o nulla) dalla GE quando sara’ chiaro il FOE per il 2021
- Nella Tascona:
  - 730keu Spese CORE in bassa priorita’ per CMS e ATLAS fase2
  - 760keu ½ MOF-B CMS+ATLAS+LHCb
  - 343keu Sj per calcolo Tier2
  - 200keu per fondo ProjectAss al CERN per attivita’ ½ FCC/MuCol ½ altro esperimento
    - Idea da discutere con GE
  - 250keu indiviso per altre iniziative
  - + altre piccole cose
- Sperabilmente e’ una precauzione che non avra’ conseguenze e la tascona sara’ assegnata nel 2021.

## Test di T e CPT con i K neutri

Processes under study:

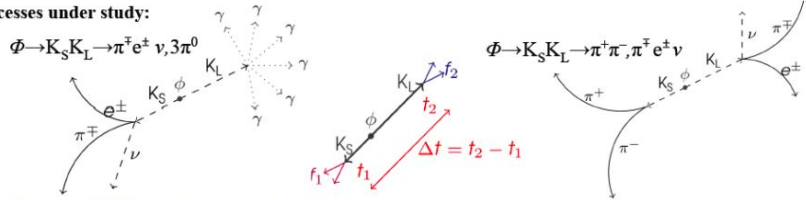

•  $L = 1.7 \text{ fb}^{-1}$  analizzati

$$R_4^{CP}(\Delta t) = \frac{I(\pi^+\pi^-, \pi^-e^+\nu; \Delta t)}{I(\pi^+\pi^-, \pi^+e^-\bar{\nu}; \Delta t)}$$

Expected:

$$R_4^{CP}(\Delta t \gg \tau_S) = 1 + 4\Re\epsilon \approx 1.0064$$

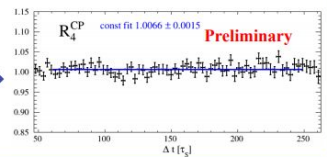

T asymmetric

$$\frac{R_2^T}{R_4^T} = \frac{I(3\pi^0, e^-) I(\pi^+\pi^-, e^-)}{I(3\pi^0, e^+) I(\pi^+\pi^-, e^+)}$$

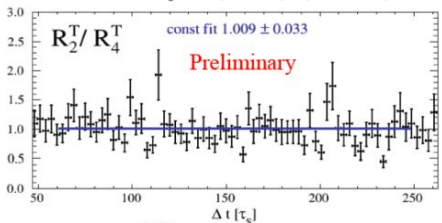

CPT asymmetric

$$\frac{R_2^{CPT}}{R_4^{CPT}} = \frac{I(3\pi^0, e^-) I(\pi^+\pi^-, e^+)}{I(3\pi^0, e^+) I(\pi^+\pi^-, e^-)}$$

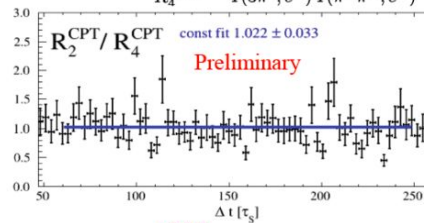

Aspettati:  $\frac{R_2^T}{R_4^T} = 1 - 8 \Re(\epsilon)$

$\frac{R_2^{CPT}}{R_4^{CPT}} = 1 - 8 \Re(\delta)$



## $\eta \rightarrow \pi^+\pi^-$



- Nuovo limite superiore ottenuto dall'analisi di  $L = 1.6 \text{ fb}^{-1}$
  - Principale background:  $e^+e^- \rightarrow \pi^+\pi^-\gamma$
- $Br(\eta \rightarrow \pi^+\pi^-) < 4.9 \times 10^{-6}$   
@ 90% C.L.

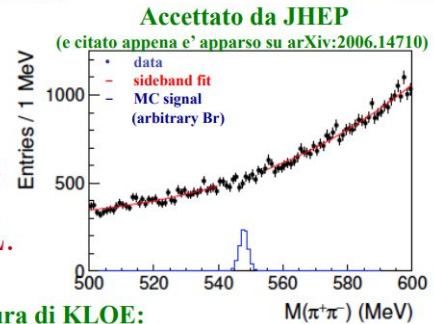

- Limite combinato con la vecchia misura di KLOE:
- $Br(\eta \rightarrow \pi^+\pi^-) < 4.4 \times 10^{-6}$  @ 90% C.L.

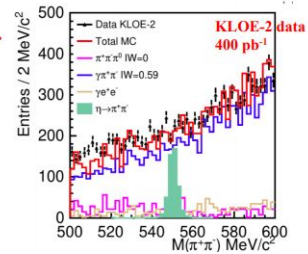

- Limite aspettato usando tutta la statistica di KLOE + KLOE-2:  $\sim 2.5 \times 10^{-6}$

P.Gauzzi

CSNI - Perugia

E' un processo che viola P e CP

Nello SM e' prodotto dalla fase della matrice CKM:  $Br \sim 3 \times 10^{-29}$

# Mu2e S.Miscetti , LNF/INFN

- Transport Solenoid mechanically connected
- Tracker in problematic state

Diversi aspetti dell'assemblaggio dei piani e stazioni sono ancora da definire, e' stato richiesto un aiuto all'INFN.

Sono stati identificati 4 attività, anche tenendo conto delle limitazioni legate al COVID-19:

- a) b) Design and production of fixturing for tracker panel testing **and** final assembly.
- c) Design and assembly of the cooling ring for each tracker plane.
- d) Design and production of fixturing for assembling tracker planes into the final tracker frame.

- Calo: All crystals received
  - Good progress on electronics and mechanics
- Major issue with access to FNAL for work
- Ritardo COVID stimato a 5 mesi
  - Detector installation end 2021
  - Commissioning w/ beams Q3/2023 (was Q1/2023)

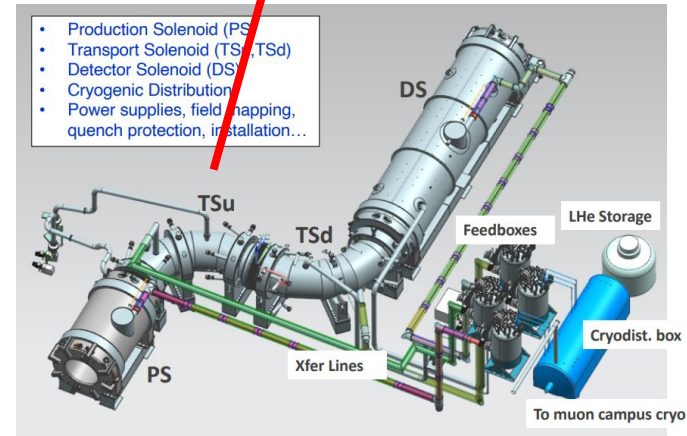

# G Minus2 Graziano Venanzoni



## Novita' dalla teoria



T. Aoyama «The anomalous magnetic moment of the muon in the Standard Model», June 8, 2020, 194 pages, e-print: 2006.04822 [hep-ph] (~50 citations) <https://news.fnal.gov/2020/06/physicists-publish-worldwide-consensus-of-muon-magnetic-moment-calculation/>

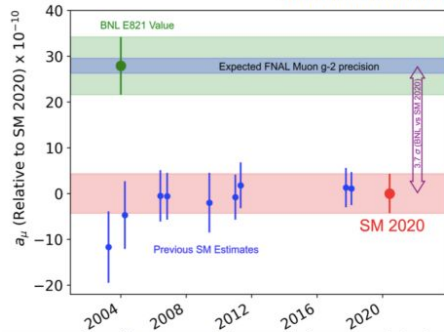

Contribution	Value $\times 10^{11}$
Experiment (E821)	116 592.089(63)
HVP LO ( $e^+e^-$ )	6931(40)
HVP NLO ( $e^+e^-$ )	-98.3(7)
HVP NNLO ( $e^+e^-$ )	12.4(1)
HVP LO (lattice, $uds$ )	7116(184)
HLbL (phenomenology)	92(19)
HLbL NLO (phenomenology)	2(1)
HLbL (lattice, $uds$ )	79(35)
HLbL (phenomenology + lattice)	90(17)
QED	116 584 718.931(104)
Electroweak	153.6(1.0)
HVP ( $e^+e^-$ , LO + NLO + NNLO)	6845(40)
HLbL (phenomenology + lattice + NLO)	92(18)
Total SM Value	116 591 810(43)
Difference: $\Delta a_\mu := a_\mu^{exp} - a_\mu^{SM}$	279(76)

$$\Delta a_\mu = (279 \pm 76) \times 10^{-11} = 3.7\sigma$$

$$(\Delta a_\mu \sim 2300 \text{ppb})$$

- Results of 4 years efforts of Theory Initiative (>170 people)
- No surprise (although one single number)
- HVP LO largest contribution ( $\rightarrow$  MUoNE)

- Completato Run3 (in anticipo causa Covid)
- 7.4 x BNL

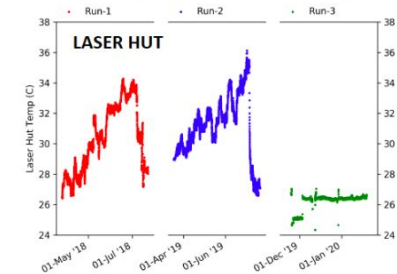
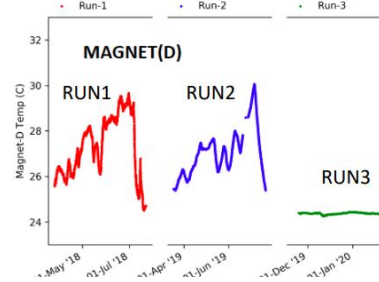
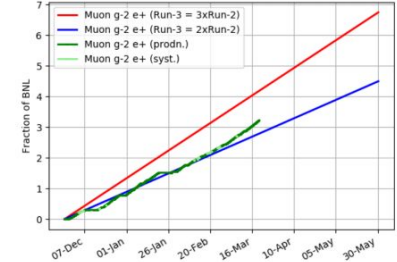
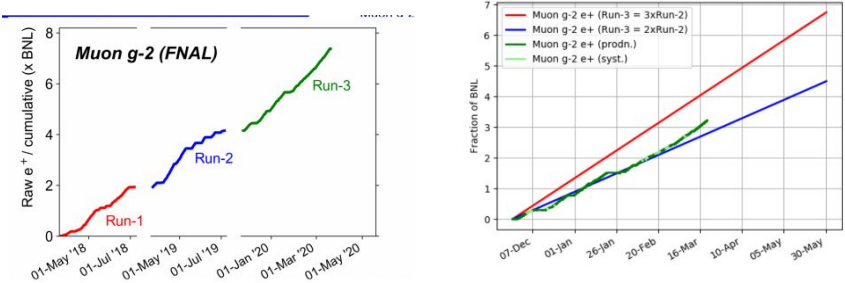

Notevole incremento della stabilità della temperatura del magnete e della Laser Hut nel Run3 rispetto Run 1&2.

## $\omega_a$ Measure

- Muon's spin is correlated to high energy positron's momentum
- The number of positrons is modulated by the anomalous precession frequency
 
$$N_0 e^{-t/\tau} [1 - A \cos(\omega_a t + \phi)]$$
- 4 different analysis methods:
  - T: integrate all positrons above 1.7 GeV

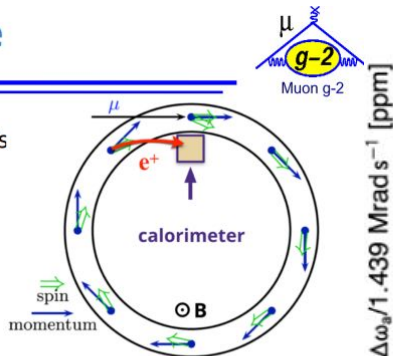

## T-method Wiggle Plot

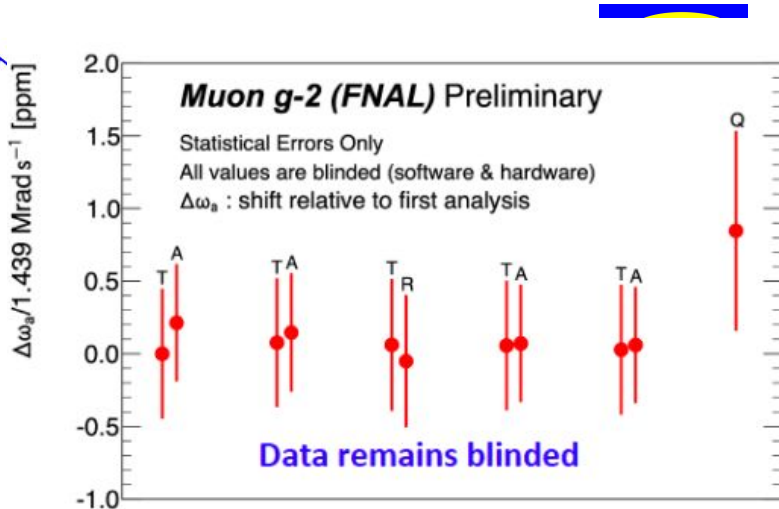
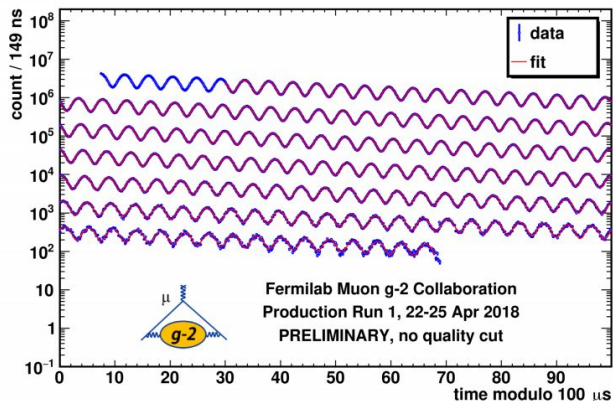

- expect **430 ppb** statistical uncertainty (compare to 460 ppb for BNL)
- Syst. error on  $\omega_a$  expected to be  $O(100)$  ppb (inc. corrections for beam dynamics)
- Goal e989: 70 ppb

19

- Analisi RUN1 in corso. Risultato atteso per la fine dell'anno con errore totale  $\sim 0.5$ ppm.
- Nel frattempo analisi RUN2 e RUN3 ( $\sim 5$  xBNL) in progress.
- Partenza Run4 a novembre2020->luglio2021

# MuonE U. Marconi

- misura dello shift adronico di  $\alpha(t)$  mediante scattering elastico  $\mu e$
- con l'obiettivo di determinare il contributo  $a_{\mu}^{\text{HLO}}$  al momento magnetico anomalo del muone con una incertezza statistica di 0.3% con 2 anni di presa dati

- Main activity: **test run in Q4 2021**
- rotating 2S sensors improves resolution: charge shared between two strips

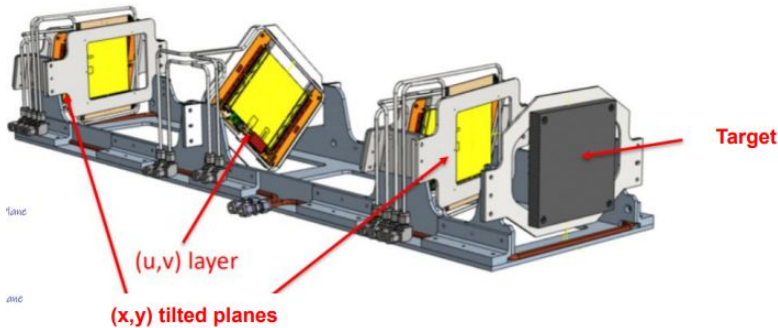

- ECAL: for TR2021 14x14 cm<sup>2</sup>
  - 25 PWO crystals provided from CMS:
  - Mechanics and thermal stability Padova

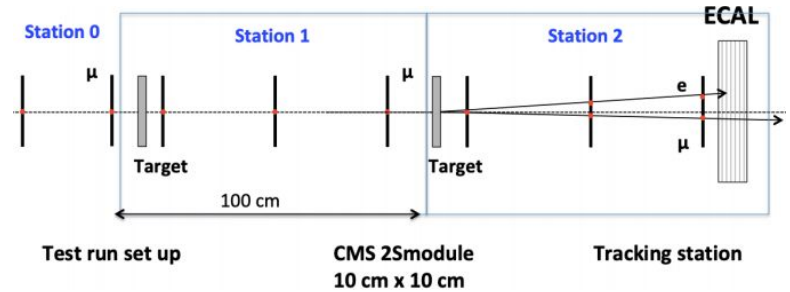
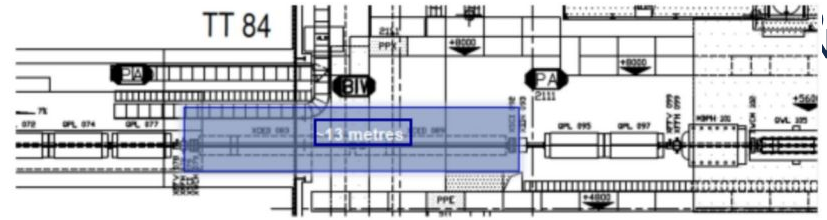

Adjustable position with respect to the beam

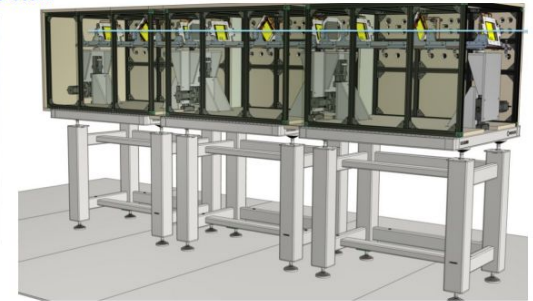
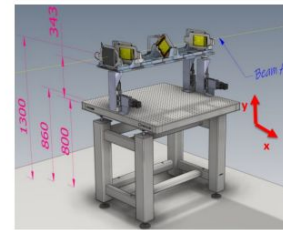

The enclosure thermally isolates the tracker, and provides connections to the services.



- No trigger, direct data flow: 20 GB/s
  - Split on 4 servers
  - 2 TB/h/server
  - Server disk to provide 1 day of capacity

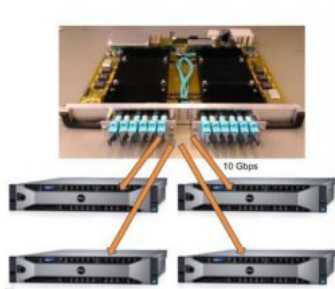

## Analysis cont.d

- $10^9$  elastic  $\mu e$  events expected from the TestRun 2021
- Marginal sensitivity to the hadronic running of  $\alpha(q^2)$
- The leptonic running could be measured with  $<5\%$  error
- Error statistically dominated
- Systematics: main focus of the analysis

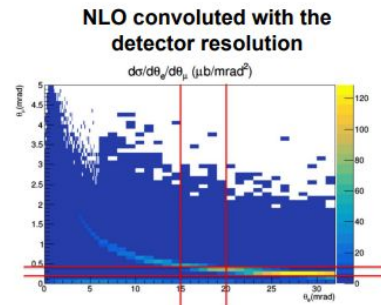
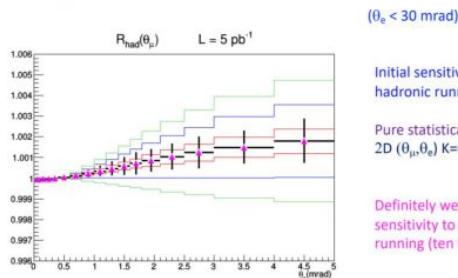

## Considerazioni dei referee

- l'esito del Pilot Run è decisivo per l'approvazione finale della misura proposta da MUonE
  - hardware e software devono essere pronti da qui ad un anno
  - per questo abbiamo chiesto a MUonE di indicare delle Milestone in modo da verificare lo stato di preparazione a step intermedi
  - importante ottimizzare nel Pilot Run l'angolo di tilt dei moduli del Tracker
  - il Pilot Run dovrà essere utilizzato anche per testare l'utilizzo di strumenti software per misura della posizione dei moduli del Tracker
- un impatto maggiore in termini di FTE/persona

## NA62 preliminary result (2016+2017+2018 data)

$$Br_{16+17+18}^{NA62}(K^+ \rightarrow \pi^+ \nu \bar{\nu}) = (1.10_{-0.35}^{+0.40} \text{stat} \pm 0.03_{\text{sys}}) \cdot 10^{-10}$$

3.5 $\sigma$  significance,  $P(\text{only bkg}) = 2 \cdot 10^{-4}$

## Homepages INFN/CERN

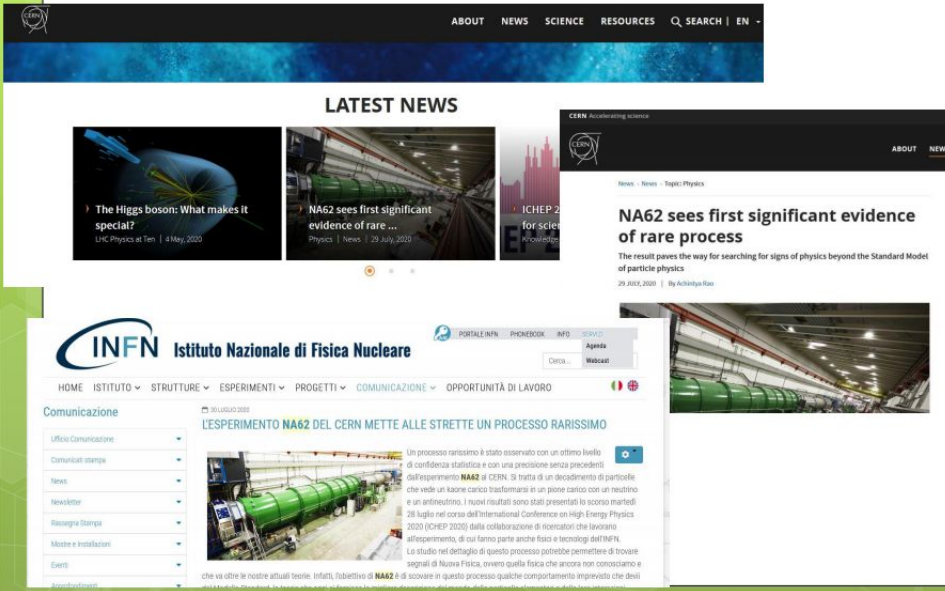

The screenshot shows the INFN website with a navigation bar (ABOUT, NEWS, SCIENCE, RESOURCES, SEARCH, EN) and a 'LATEST NEWS' section. The main article is titled 'NA62 sees first significant evidence of rare process' with a sub-headline 'The result paves the way for searching for signs of physics beyond the Standard Model of particle physics'. The article is dated 29 JULIO, 2020 and is by Archivia Rao. There is also a smaller article snippet about 'The Higgs boson: What makes it special?'.

## SIF, Science Times etc.



The screenshot shows two news websites. On the left is the SIF (Società Italiana di Fisica) website, featuring a headline 'NA62 sees first significant evidence of rare process' and a sub-headline 'L'insegnamento della fisica nelle scuole: monitorare, incentivare e aggiornare!'. On the right is the Science Times website, featuring a headline 'NA62 experiment at CERN reports first evidence for ultra-rare process that could lead to new physics' and a sub-headline 'CERN Finds New Evidence of Ultrarare Process That Could Explain Dark Matter'.

## PNN: cinematica

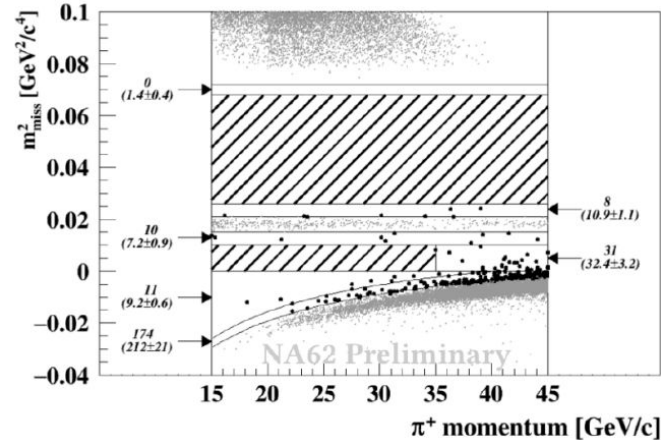
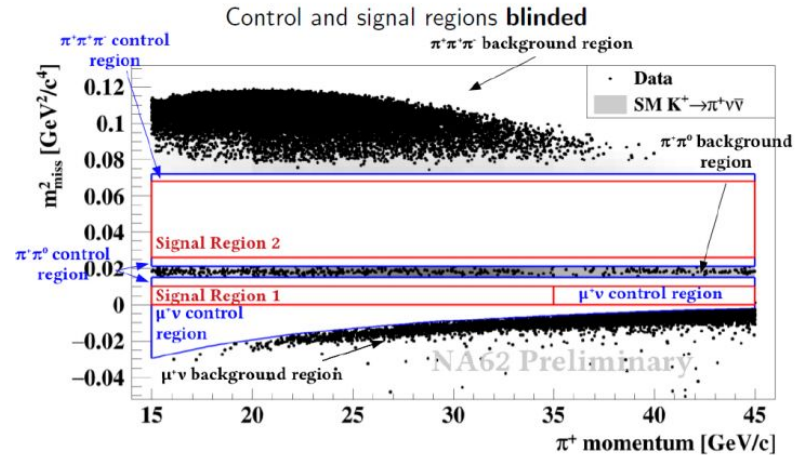
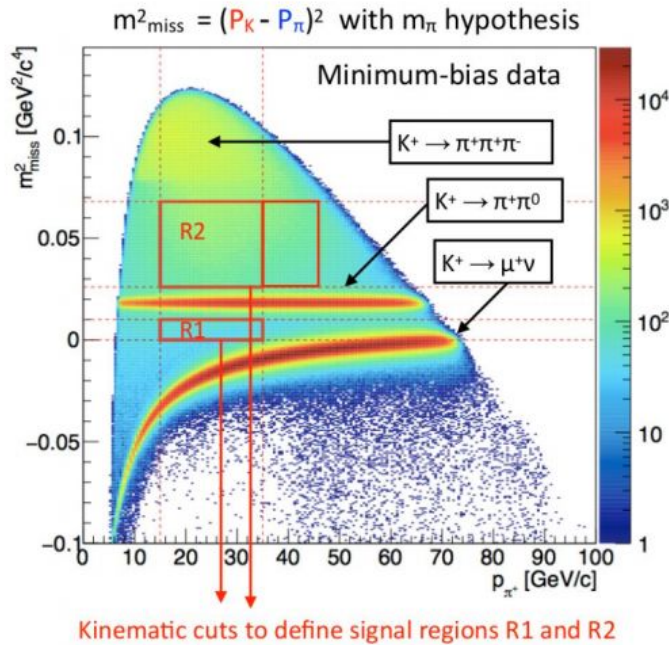

# PNN: opening the box

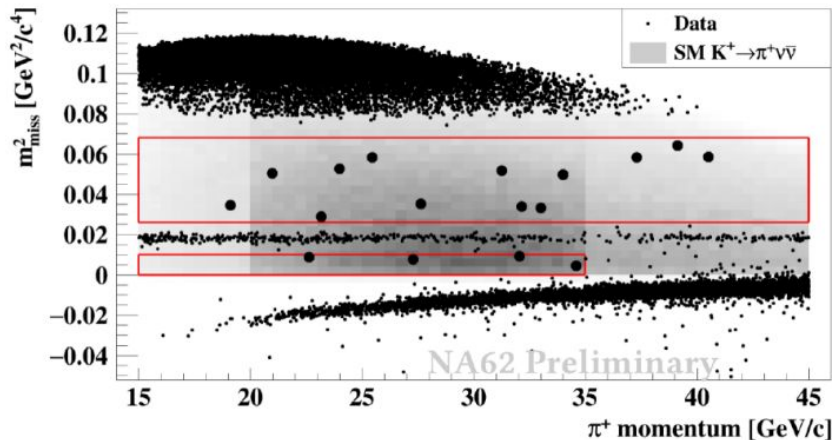

Expected SM signal events:  $7.58 \pm 0.40_{\text{syst}} \pm 0.75_{\text{ext}}$ ,  
 expected background events:  $5.28^{+0.99}_{-0.74}$ ,  
**observed events: 17**

	2016 data	2017 data	2018 data
SES	$(3.15 \pm 0.24) \cdot 10^{-10}$	$(0.39 \pm 0.02) \cdot 10^{-10}$	$(0.111 \pm 0.007) \cdot 10^{-10}$
Expected SM signal	$0.27 \pm 0.04$	$2.16 \pm 0.29$	$7.58 \pm 0.85$
Expected background	$0.15 \pm 0.09$	$1.50 \pm 0.31$	$5.28^{+0.99}_{-0.74}$
Observed events	1	2	17

- $B_{16+17+18}^{NA62}(K^+ \rightarrow \pi^+ \nu \bar{\nu}) = (1.10^{+0.40}_{-0.35\text{stat}} \pm 0.03_{\text{syst}}) \cdot 10^{-10}$  (Preliminary)
- $B_r^{SM}(K^+ \rightarrow \pi^+ \nu \bar{\nu}) = (0.84 \pm 0.10) \cdot 10^{-10}$  [Buras et al., JHEP11(2015)033]

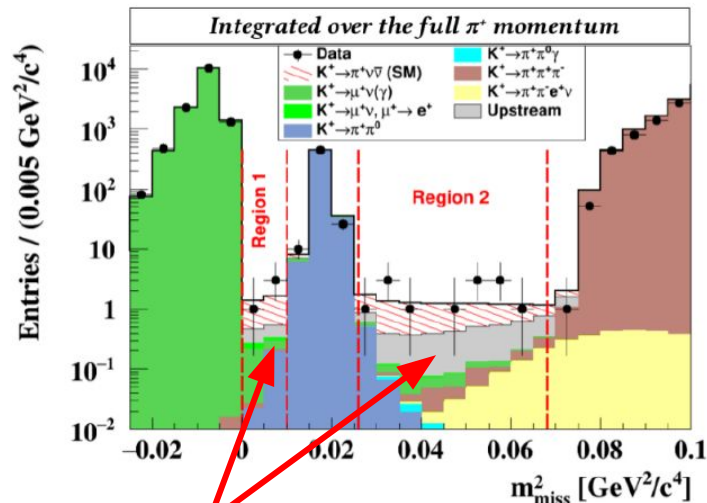

## PNN: riduzione fondo upstream

Replacement of the final collimator against Upstream bkg  
 (June 2018)

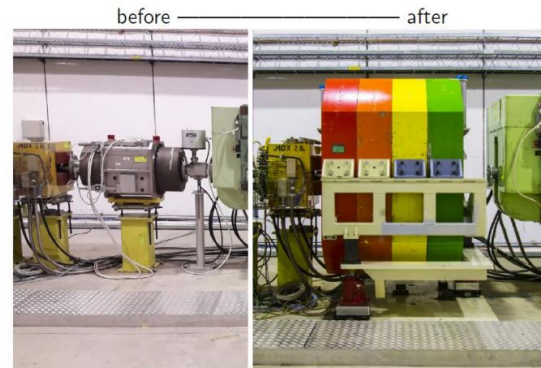

# Altri risultati

Miglioramento 10x



## Study of the decay $K^+ \rightarrow \pi^+ \mu^+ \mu^-$ : Comparison with the existing measurements

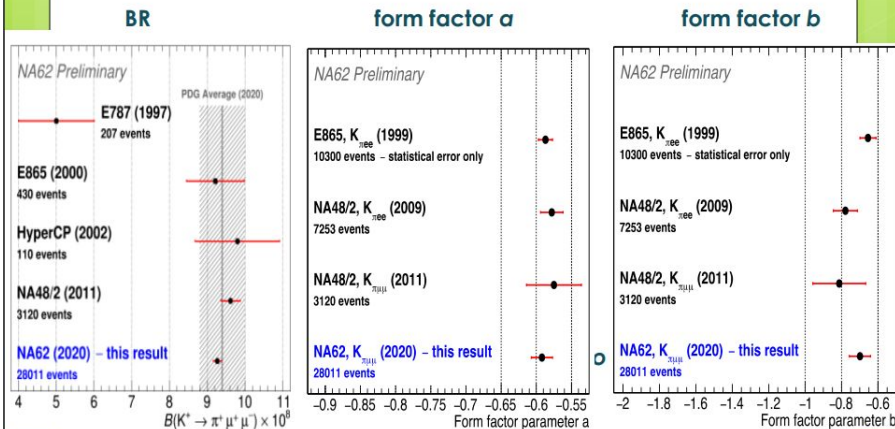

Misura al 1% di BR(10<sup>-7</sup>)

- Near future: 18 settimane di fascio da 17/7/2021
- Longer future: KLever misura  $KL \rightarrow \pi^0 \nu \bar{\nu}$  at SPS
  - Presentato a Snowmass

## LFV/LNV : Results

18 CSN1 Perugia 28/09/2020

Experimental strategy: precise three tracks vertex reconstruction, particle ID (LKr+MUV3)  
 Background: mis-ID  $e^+e^- \rightarrow \pi^{\pm}$  (data-driven estimation),  $\pi^{\pm}$  decay in flight  
 Normalization:  $K^+ \rightarrow \pi^+ \pi^+ \pi^-$

0.92 ± 0.34 bkg exp, 2 Obs., p-value 24%

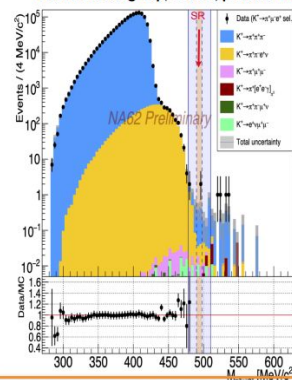

$Br(K^+ \rightarrow \pi^+ \mu^+ e^-) < 6.6 \times 10^{-11}$  @ 90% C.L.

1.06 ± 0.20 bkg expected, 0 Obs.

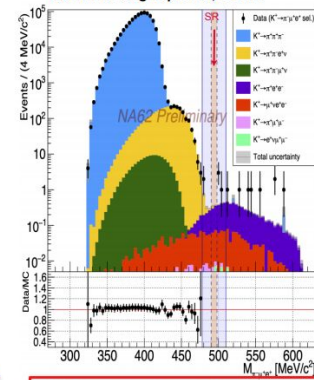

$Br(K^+ \rightarrow \pi^+ \mu^+ e^-) < 4.2 \times 10^{-11}$  @ 90% C.L.

Analysis:  
INFN  
(E. Minucci)

## A $K_L \rightarrow \pi^0 \nu \bar{\nu}$ experiment at the SPS



400-GeV SPS proton beam ( $2 \times 10^{13}$  pot/16.8 s)  
 incident on Be target at  $z = 0$  m

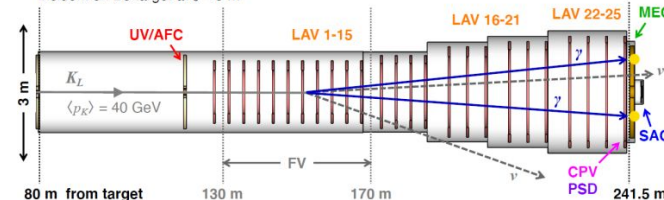

# ATLAS LS2 Davide Boscherini

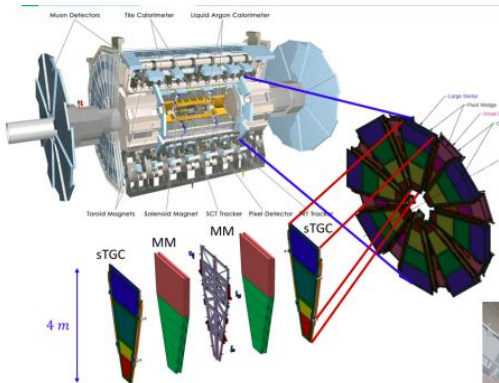

- Mu e trigger
- NSW-A pronta Ago 2021
- NSW-C ritardi sTGC (Cile e Canada) Oct 2021

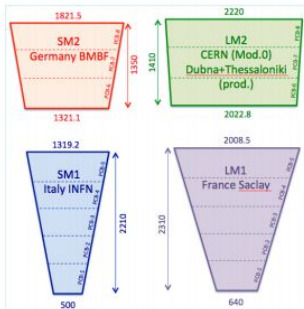

## New Small Wheel detector

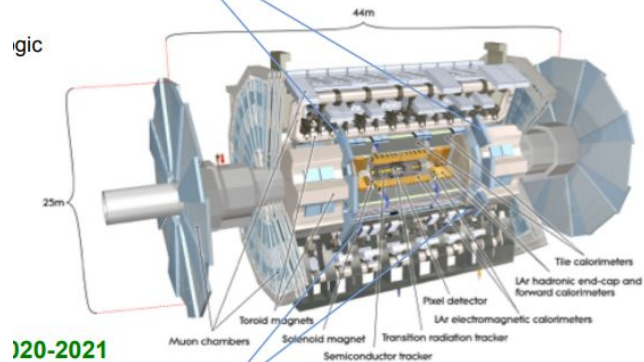

## New Muon RPC detector (BIS78)

## Installazione in ATLAS

- L'installazione in ATLAS della prima stazione BIS78 (A04) è stata completata con successo il 18 Settembre;
- Questa settimana è prevista l'installazione della stazione A06;

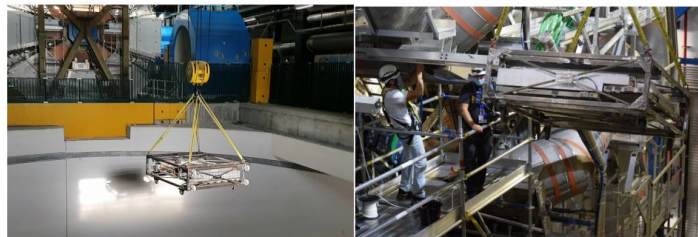

# ATLAS Highlight fisica

## Higgs Physics: VH( → bb)

Gruppi italiani in Higgs e HH searches: BO, CS, LNF, GE, MI, PI, PV, RM1, RM3, TIFFA, UD

arXiv:2008.02508

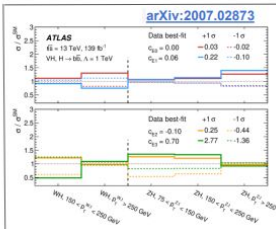
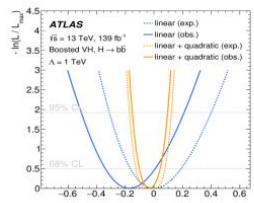
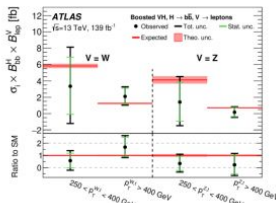
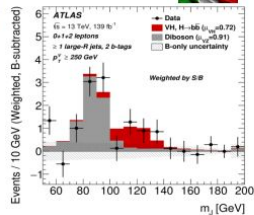

## Publicazioni ATLAS

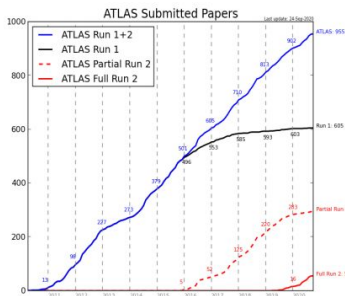

ATLAS - Papers/Lead-group

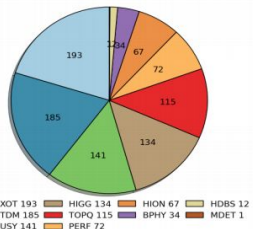

## Standard Model Physics: Lepton Flavour Universality

arXiv:2007.14040 Submitted to Nature

- Test of the W boson couplings with  $\mu$  and  $\tau$  in di-leptonic tt events
- Full Run 2 statistics: 139 fb<sup>-1</sup>
- Prompt muons from W
- Muons from  $\tau$  are distinguished from prompt using:
  - Impact parameter d0,  $\tau$  lifetime and kinematic properties
- Main backgrounds:
  - Z →  $\mu\mu$  + jets events
  - $\mu$  from non-W events

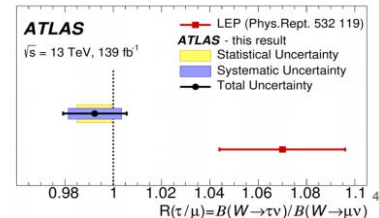
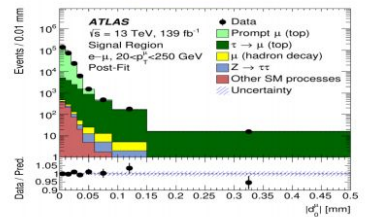

Gruppi italiani in Standard Model: BO, CS, GE, MI, NA, RM1, RM2

Gruppi italiani in Top physics: BO, CS, RM2, RM3, UD

## Top Physics: 4 tops evidence

https://arxiv.org/abs/2007.14858 Submitted to EPJC

- First evidence of 4 top-quarks production!
- Full Run 2 statistics (139 fb<sup>-1</sup>)
- Same-sign and three lepton channels combined → Low background
- To further suppress the background, use of multivariate discriminants on:
  - Number of jets
  - Number of b-jets
  - Event kinematic
- $\sigma(4t) = 24_{-6}^{+7}$  fb
- Significance:
  - Expected 2.7 $\sigma$
  - Observed 4.2 $\sigma$

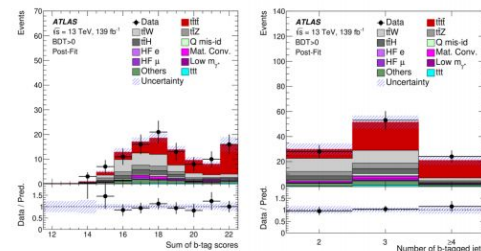
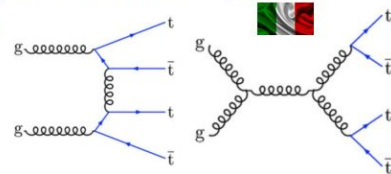

- GE1/1 installation completed last week
- first installed Phase-II detector!

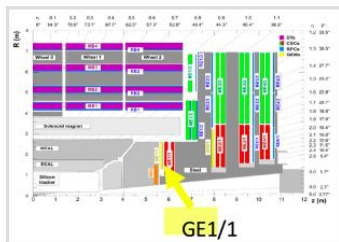

Congratulations!

see also: [CMS GEM's shine on](#)



A new technology (GEM) to complement the muon system

The GEM 1/1 project construction and installation was completed on Sep 14 on budget and on time!!  
Not trivial considered COVID.

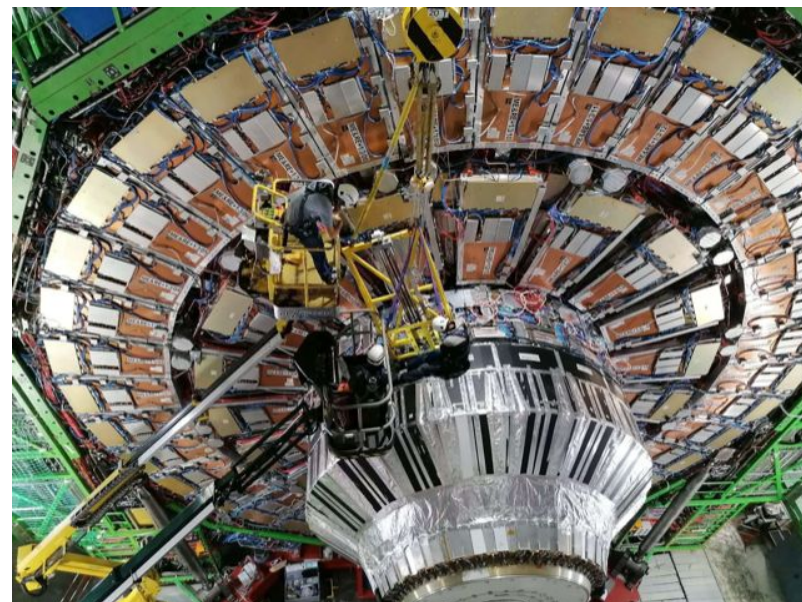

Da Settembre L.Malgeri in place of R.Carlin as SP  
A fine ottobre CMS-italia elegge nuovo RN



# CMS highlight fisica

### $H \rightarrow \mu\mu$



arXiv:2009.04363  
sub. JHEP

- Test coupling seconda generazione
- In SM  $BR(H \rightarrow \mu\mu) \sim 2 \cdot 10^{-4}$
- Richiesta di muoni isolati ad alto  $p_T$
- Categorie di produzione
  - ggH, VBF, ttH, VH
  - VBF da fit DNN

Separazione in categorie MVA score

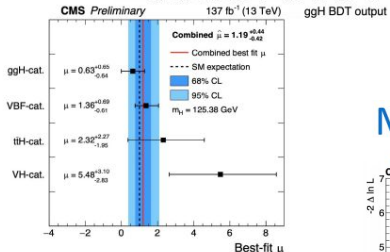
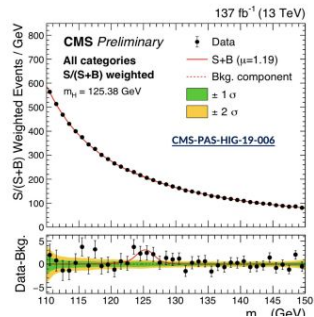

$$\mu = 1.19^{+0.41}_{-0.39} (stat) + 0.17^{+0.17}_{-0.16} (syst)$$

per  $m_H = 125.38$  GeV

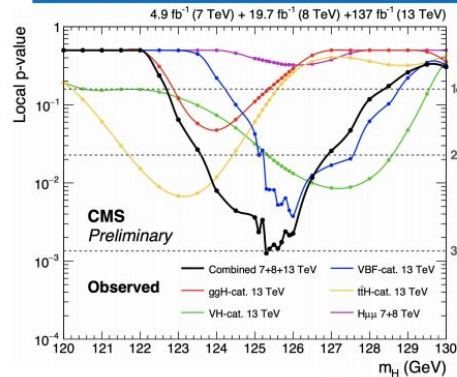
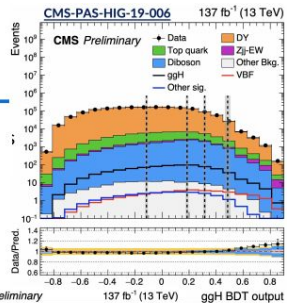

Ancora limitato da incertezza statistica  
→ Run3 fondamentale

### Massa $H^0$



Phys. Lett. B 805 (2020) 135425

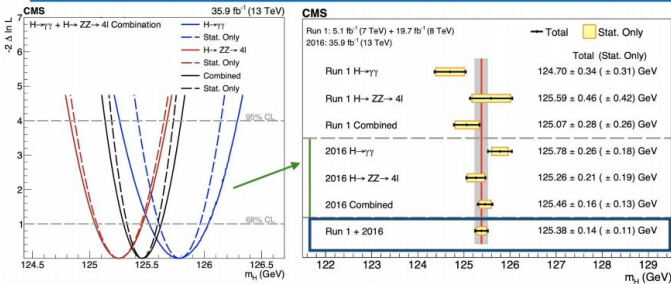

Combinazione  $\gamma\gamma$  e  $ZZ$  (Run1+2016)

$$m_H = 125.38 \pm 0.14 \text{ miglioramento fattore 2 da Run1}$$

Stessa incertezza di combinazione PDG attuale

### Eccesso a $3\sigma$

Prod. Category	Obs. (exp.) significance ( $m_H = 125.38$ GeV)
VBF	2.40 (1.77)
ggH	0.99 (1.56)
ttH	1.20 (0.54)
VH	2.02 (0.42)
Comb. 13 TeV	2.95 (2.46)
Comb Run 1+2	2.98 (2.48)

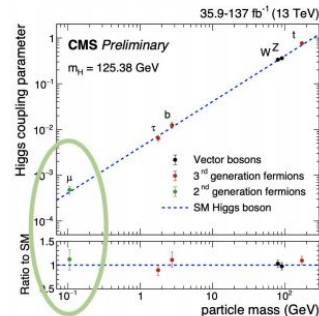

# CMS highlight fisica M.Pelliccioni



## Prima osservazione VVV

arXiv:2006.11191  
Accettato da PRL  
1000esimo paper inviato!

- Test fondamentale non-abelianita' EWK
- Accoppiamenti quartici e tripli (mediati H)

Targeted signal	Same-sign	3 leptons	4 leptons	5 leptons	6 leptons
	$W^\pm \rightarrow l^\pm \nu$	$W \rightarrow l \nu$	$W \rightarrow l \nu$	$W \rightarrow l \nu$	$Z \rightarrow ll$
	$W^\pm \rightarrow l^\pm \nu$	$W \rightarrow l \nu$	$W \rightarrow l \nu$	$Z \rightarrow ll$	$Z \rightarrow ll$
	$W^\pm \rightarrow qq$	$W \rightarrow l \nu$	$Z \rightarrow ll$	$Z \rightarrow ll$	$Z \rightarrow ll$

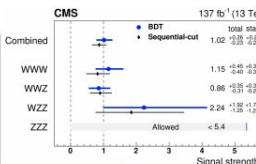
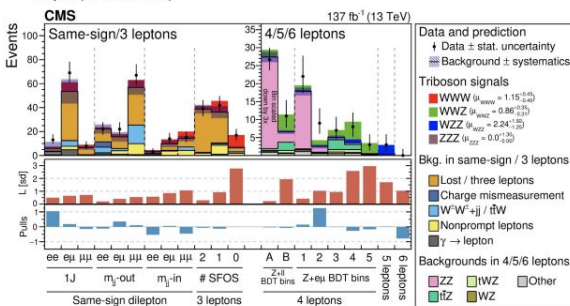

Stato finale	Significativita' [ $\sigma$ ]
WWW	3.3 (3.1)
WWZ	3.4 (4.1)
WZZ	1.7 (0.7)
ZZZ	0 (0.9)
Combinato	5.7 (5.9)

Evidenza WWW e WWZ e osservazione VVV  
Tutti canali completamente dominati da incertezze statistiche

Grande contributo Padova:  
A.Bragagnolo e E.Lusiani

## CPV in $B_s \rightarrow J/\psi \phi(KK)$

Misura di  $\phi_s$  e  $\Delta\Gamma_s$   
Analisi time-dep con trigger dedicato (17/18)  
Flavor tagger su muone utilizza ML  
Include prob. mistag per evento  
Miglioramento significativo analisi 8 TeV

INFN CMS-BPH-20-001  
sub PLB

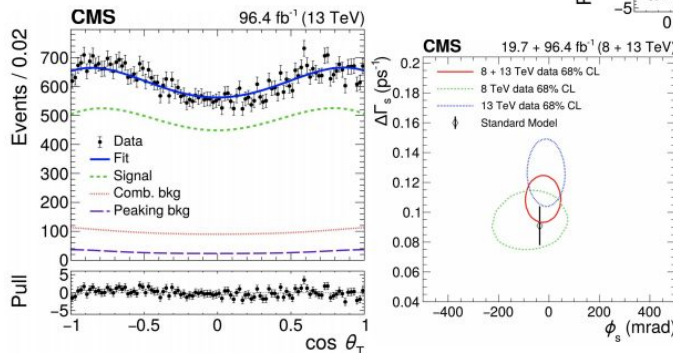
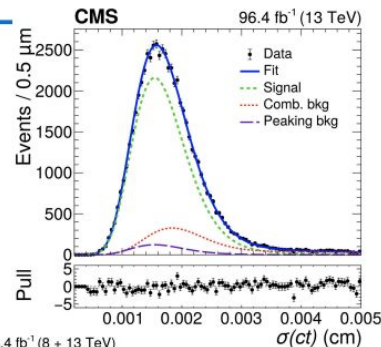

Combinazione 8+13 TeV

$$\phi_s = -21 \pm 45 \text{ mrad}$$

$$\Delta\Gamma_s = 0.1073 \pm 0.0097 \text{ ps}^{-1}$$

### DT Phase 2

#### Milestone: EDR on June 25

Outcome was very positive, allowing to proceed with core expenditures up to the ESR expected in April 2021.

<https://indico.cern.ch/event/921853/>



**OBDT pre-production design** is ongoing (major change is the replacement of the GBTx with the the IpGBT). First prototypes expected by next year.

#### Slice test: One sector equipped with several OBDT prototypes

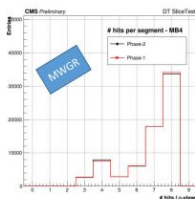
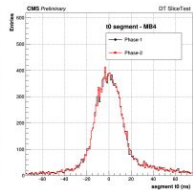

Time of cosmic muon computed by fitting the muon segment track in a DT chamber, using the **phase-1** and **phase-2** electronics

+ No difference observed

+ Successfully included in MWGR



**Shielding** - Resuming activity now to install some pending vertical sectors

**Extraction of a MB2 for repairing LV in SL Theta**

7

### SiPM

– **Final step of Market Survey:** two vendors

‣ Plan to test ~200 pre-series arrays (April 2021) per vendor

‣ Tender in Summer 2021

– **Substantial progress in SiPM irradiation and annealing studies**

‣ Confirm earlier indications of larger radiation damage than anticipated

‣ Studying mitigations (e.g. additional local cooling and in-situ annealing likely needed (thermoelectric coolers)

**Tray prototype assembly verification ongoing** (1-2 months delay):

– mock-up components and tools in hands. **Validating assembly process**

– **Functional prototype** with real modules, cooling plate and electronics aimed **for end of 2020**

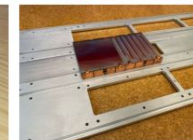
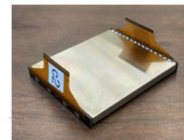
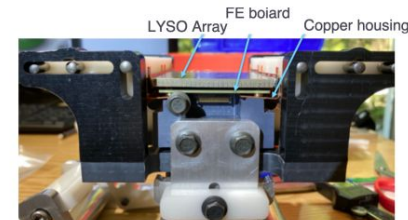
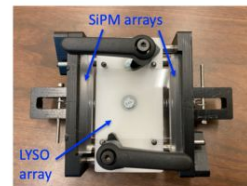

# LHCb Highlight fisica Giulia Tuci



## Violazione di CP in $B^0_{(s)} \rightarrow h^+ h^-$

M.Calvi, D.Fazzini (MIB)  
S.Perazzini, V.Vagnoni (BO)  
LHCb-PAPER-2020-029

- Diversi processi fisici contribuiscono a decadimenti  $B^0_{(s)} \rightarrow h^+ h^-$  ( $h = K, \pi$ )
  - Presenza di diagrammi con loop  $\rightarrow$  sensibilità a processi di fisica oltre il modello standard

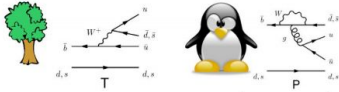

- Misura asimmetria di CP dipendente dal tempo in  $B^0 \rightarrow \pi^+ \pi^-$  e  $B^0_s \rightarrow K^+ K^-$

$$A(t) = \frac{\Gamma_{B^0_{(s)} \rightarrow f}(t) - \Gamma_{B^0_{(s)} \rightarrow \bar{f}}(t)}{\Gamma_{B^0_{(s)} \rightarrow f}(t) + \Gamma_{B^0_{(s)} \rightarrow \bar{f}}(t)} = \frac{-C_f \cos(\Delta m_{d(s)} t) + S_f \sin(\Delta m_{d(s)} t)}{\cosh\left(\frac{\Delta\Gamma_{d(s)}}{2} t\right) + A_f^{\Delta\Gamma} \sinh\left(\frac{\Delta\Gamma_{d(s)}}{2} t\right)}$$

$$C_f \equiv \frac{1 - |\lambda_f|^2}{1 + |\lambda_f|^2}, \quad S_f \equiv \frac{2\text{Im}\lambda_f}{1 + |\lambda_f|^2}, \quad A_f^{\Delta\Gamma} \equiv -\frac{2\text{Re}\lambda_f}{1 + |\lambda_f|^2}, \quad \lambda_f \equiv \frac{q \bar{A}_f}{p A_f}$$

Violazione di CP nel decadimento

Violazione di CP nell'interferenza tra decadimento e mixing

- Misurata anche asimmetria di CP integrata nel tempo in  $B^0 \rightarrow K^+ \pi^-$  e  $B^0_s \rightarrow \pi^+ K^-$

## LHCb-PAPER-2020-029

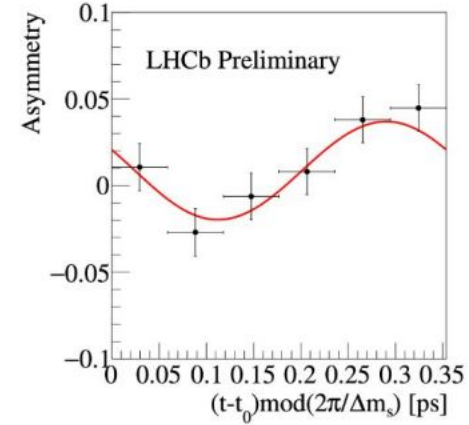
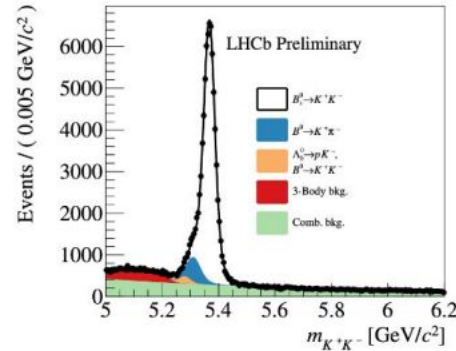

- Combinazione con misura Run1 PRD 98 (2018) 032004

$$C_{\pi\pi} = -0.320 \pm 0.038$$

$$S_{\pi\pi} = -0.672 \pm 0.034$$

$$A_{CP}^{B^0} = -0.0831 \pm 0.0034$$

$$A_{CP}^{B^0_s} = 0.225 \pm 0.012$$

$$C_{KK} = 0.172 \pm 0.031$$

$$S_{KK} = 0.139 \pm 0.032$$

$$A_{KK}^{\Delta\Gamma} = -0.897 \pm 0.087$$

$$(C_{KK}, S_{KK}, A_{KK}^{\Delta\Gamma}) \neq (0, 0, -1) @ 6.5 \sigma$$

**Prima osservazione di violazione di CP dipendente dal tempo nei mesoni  $B^0_s$**

# LHCb Highlight fisica

## Misura angolo $\gamma$

LHCb-CONF-2020-001

- Lo stato finale di  $B^\pm \rightarrow (D^0 \rightarrow K_S^0 h^+ h^-) K^\pm$  è accessibile sia con decadimenti  $D^0$  e  $\bar{D}^0 \rightarrow$  interferenza  $\rightarrow$  misura angolo  $\gamma$

$B^\pm \rightarrow D\pi^\pm$  come canale di controllo

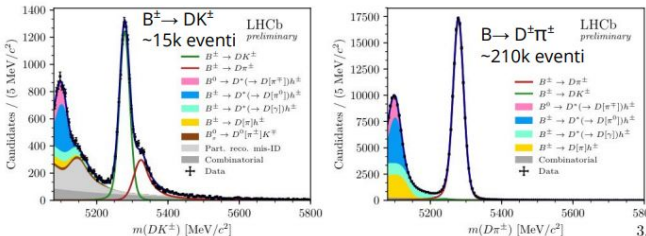

- Utilizzato dataset completo 2011-2018
- Dalitz plot diviso in bin e angolo  $\gamma$  estratto da un fit a  $N_i^\pm \rightarrow$  fondamentale input da BESIII per fase forte [PRL 124, 241802 (2020)]

$\gamma = (69 \pm 5)^\circ$  Misura più precisa al mondo!

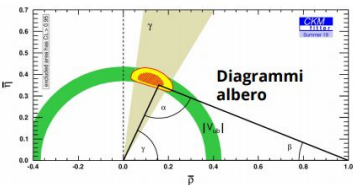
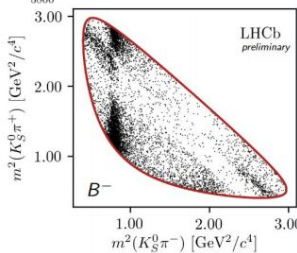
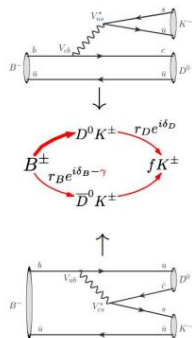

$\gamma = (72.1^{+5.4}_{-5.7})^\circ$

Da diagrammi ad albero

Primo test di transizioni  $b \rightarrow sl^+ l^-$  nei barioni  $\Lambda_b^0$

$\Lambda_b^0 \rightarrow pK^+ e^+ e^-$ ,  $\Lambda_b^0 \rightarrow pK^+ \mu^+ \mu^-$

$$R_{pK}^{-1} = \frac{\mathcal{B}(\Lambda_b^0 \rightarrow pK^- e^+ e^-)}{\mathcal{B}(\Lambda_b^0 \rightarrow pK^- J/\psi(\rightarrow e^+ e^-))} \bigg/ \frac{\mathcal{B}(\Lambda_b^0 \rightarrow pK^- \mu^+ \mu^-)}{\mathcal{B}(\Lambda_b^0 \rightarrow pK^- J/\psi(\rightarrow \mu^+ \mu^-))}$$

## Test universalità leptonica: $R_{pK}$

JHEP 05 (2020) 040

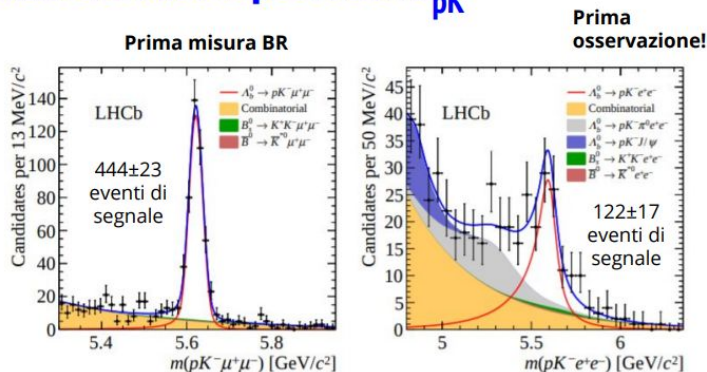

$$\mathcal{B}(\Lambda_b^0 \rightarrow pK^- \mu^+ \mu^-) \big|_{0.1 < q^2 < 6 \text{ GeV}^2/c^4} = (2.65 \pm 0.14 \pm 0.12 \pm 0.29_{-0.23}^{+0.38}) \times 10^{-7}$$

$$R_{pK}^{-1} \big|_{0.1 < q^2 < 6 \text{ GeV}^2/c^4} = 1.17_{-0.16}^{+0.18} \pm 0.07$$

$\rightarrow R_{pK}^{-1}$  compatibile con l'unità entro  $1\sigma$  (test al 16% di precisione)

## Tetraquarks

- ❖ Osservato picco significativo a  $\sim 6905$  MeV nello spettro della massa invariante  $m(J/\psi\text{-}J/\psi)$
- ❖ Possibile interpretazione  $\rightarrow T_{c\bar{c}c\bar{c}}$
- ❖ Struttura compatibile con due  $T_{c\bar{d}s u}$  osservata in  $m(D^+K^+)$  studiando 1260 decadimenti  $B^+ \rightarrow D^+D^+K^+$



L. An, L. Anderlini,  
G. Graziani (FI)

LHCb-PAPER-2020-011

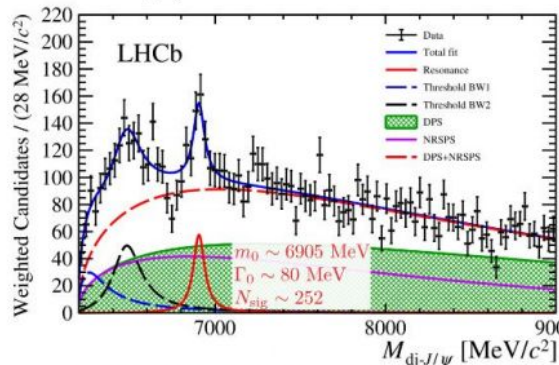

LHCb-PAPER-2020-024

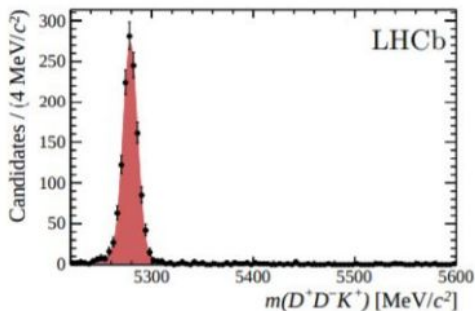

Struttura a  
 $m(D^+K^+) = 2.9 \text{ GeV} (4\sigma)$

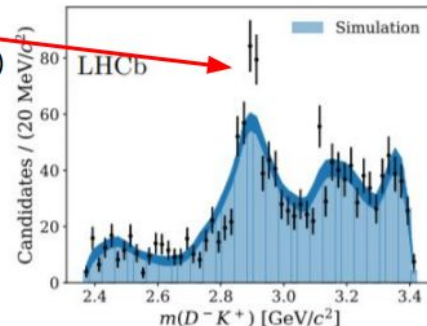

## RICH

La componente INFN, inizialmente minoritaria, è ora maggioritaria nell'era dell'upgrade (FE, GE, MiB, PD, PG)



Elementary Cell (EC)



## LHCb Upgrade I per l'INFN

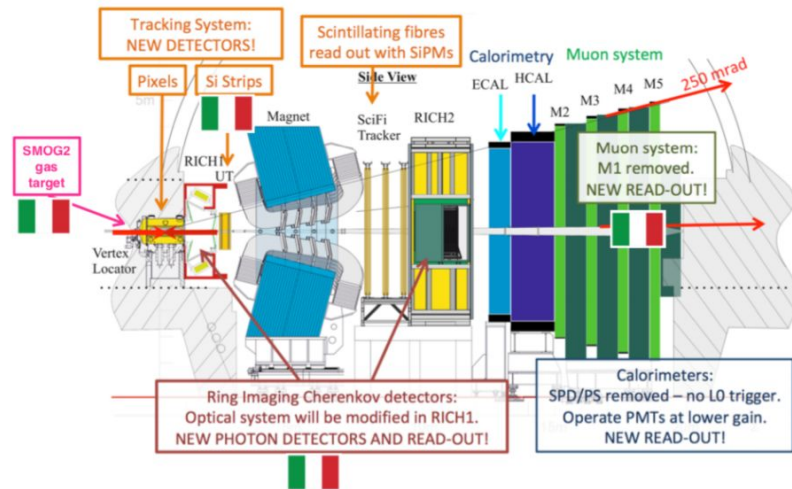

- Installazione colonne al CERN e inizio commissioning in questi giorni
- Scheda in tempo, nonostante il Covid

## Deliberation Document on the 2020 update of the European Strategy for Particle Physics

*The European Strategy Group  
(prepared by the Strategy Secretariat)*

committees and the Research Board. Among the proposals for larger-scale new facilities investigated within the Physics Beyond Colliders study, the Beam Dump Facility at the SPS emerged as one of the frontrunners. However, such a project would be difficult to resource within the CERN budget, considering the other recommendations of this Strategy.

## MEDIUM TERM PLAN 2021-2025

PBC activities are funded with an increased budget of 3 MCHF/year in this MTP (up from 1 MCHF/year). These resources will also be used to continue R&D and design studies (beam extraction and transfer, target system, radiation protection, etc.) for a beam dump facility at the SPS, so as to be ready to start construction before the end of the decade if a decision is taken on its implementation by the time of the next ESPP update.

- **BDF** facility strongly supported by CERN
- Priority will be given to aspects directly related to the facility (e.g. muon shield, magnets, decay vessel)
- The SHiP Collaboration will work on the preparation of an **R&D plan** for the facility

New satellite projects on a short timescale open to external contributions with independent Collaborations:

- LINE1:** SHiP technology applied to a different context → SND at LHC
- LINE2:** SHiP physics case on a smaller scale → mini-SHiP@PS

The Scattering and Neutrino Detector @LHC

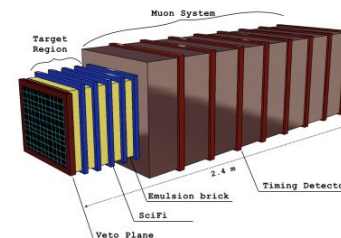



# SND@LHC motivazioni



• <http://arxiv.org/abs/1804.04413>

Bustamante and Connolly  
PRL 122 (2019) 041101

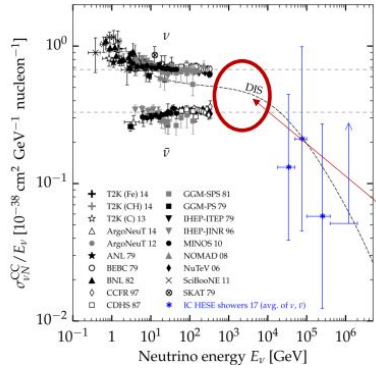

**OPEN ACCESS**  
IOP Publishing

Journal of Physics G: Nuclear and Particle Physics

J. Phys. G: Nucl. Part. Phys. 46 (2019) 115008 (19pp)

<https://doi.org/10.1088/1361-6471/ab3f7c>

## Physics potential of an experiment using LHC neutrinos

N Beni<sup>1</sup>, M Brucoli<sup>2</sup>, S Buontempo<sup>5</sup>, V Cafaro<sup>4</sup>,  
G M Dallavalle<sup>4,8</sup>, S Danzeca<sup>2</sup>, G De Lellis<sup>2,3,5</sup>,  
A Di Crescenzo<sup>3,5</sup>, V Giordano<sup>4</sup>, C Guandalini<sup>4</sup>, D Lazić<sup>6</sup>,  
S Lo Meo<sup>7</sup>, F L Navarria<sup>4</sup> and Z Szillasi<sup>1,2</sup>

CERN is unique in providing energetic  $\nu$  (from LHC)  
→ measure  $pp \rightarrow \nu X$  in an unexplored domain

See M. Dallavalle's talk, July 2019

## The SND@LHC:

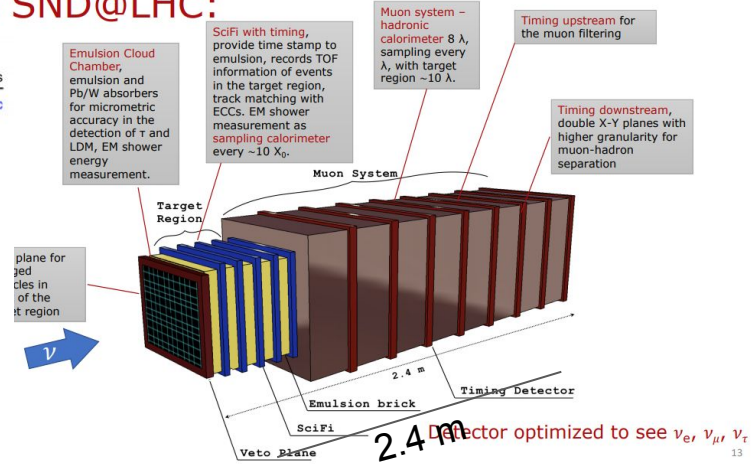

8

CERN Director of Research supports the physics case.

The following schedule was agreed with the LHCC (the Research Board took note of that)

- September 2020: LHCC review process initiated
- October 2020: questions provided by LHCC review panel to be answered in 1-2 weeks
- November 2020: focus session on the proposal at LHCC
- December 2020: submission of the Technical Proposal
- March 2021: final review with a presentation in the Open Session

- Minimal infrastructure work will be done at the end of October. Remaining infrastructure work and detector installation from March 2021 until the end of 2021.

## SND@LHC: Letter of Intent

LoI: CERN-LHCC-2020-013; LHCC-I-037  
<https://cds.cern.ch/record/2729015/files/LHCC-I-037.pdf>

## PHYSICS PERSPECTIVE: NEUTRINOS AND QCD

- $pp \rightarrow \nu X$  in the range  $7.2 < \eta < 8.7$ : neutrinos are mostly produced by charm decays
- Prediction for (beauty and) charm yield at such small angles are affected by large uncertainties and unconstrained by measurements
- None of the LHC detectors cover this range
- Neutrino detection as a tool to measure heavy flavour production at very small angles (large  $\eta$ ) → important QCD task

Stefano Lacaprra, INFN Padova

## SuperKEKB Roadmap2020

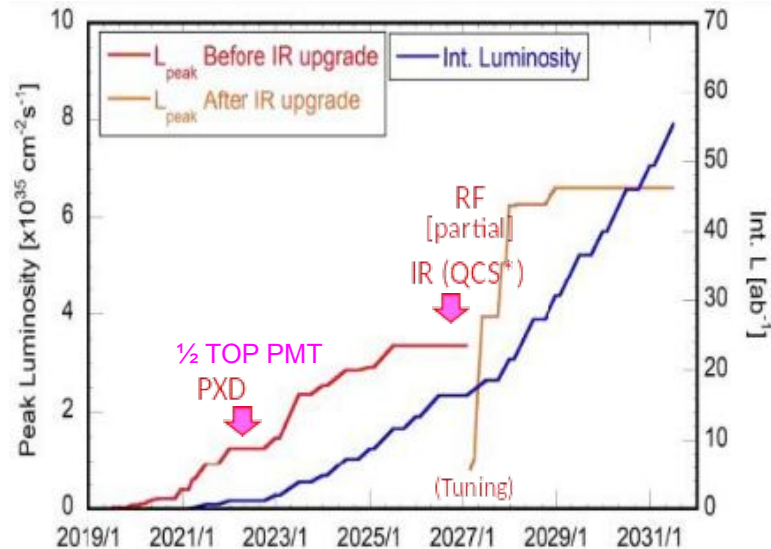

• Main reasons:

- (1) Increase in the running cost (utility cost )
- (2) Challenges found in the initial operations ( ~ 2019c ) :
  - (a) Strong beam-beam effects at high bunch-current region
  - (b) Narrow physical aperture in QCS
  - (c) High background in Belle II

## BELLE2: ROADMAP E UPGRADE

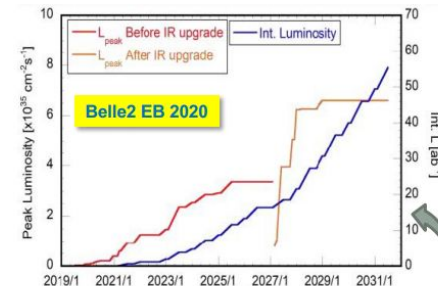
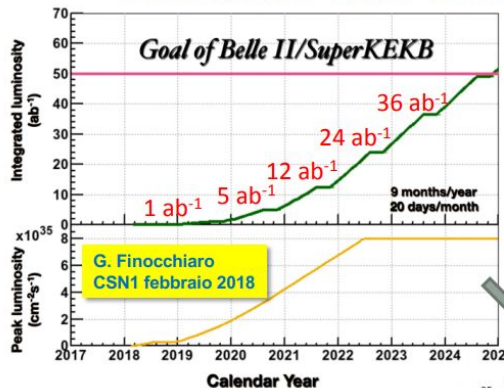

- La prospettiva temporale dell'esperimento è sostanzialmente cambiata rispetto all'inizio delle operazioni
- la macchina non è in grado di raggiungere la luminosità di design con il progetto originale
- KEK ha sottoposto un progetto di upgrade dell'acceleratore per superare alcune delle criticità osservate
- Ad esso si abbinerà un upgrade di BELLE2 che avrà un chiaro impatto sulla partecipazione INFN

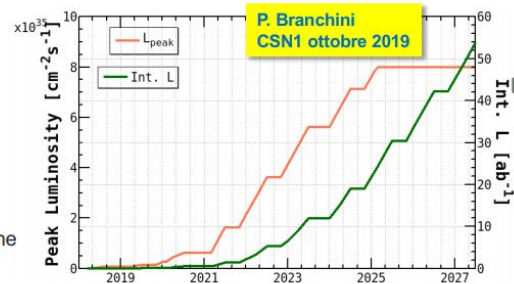

F.Cossutti  
Referee

# Belle II Run2020a/b

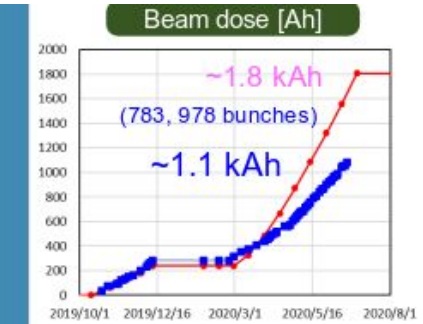
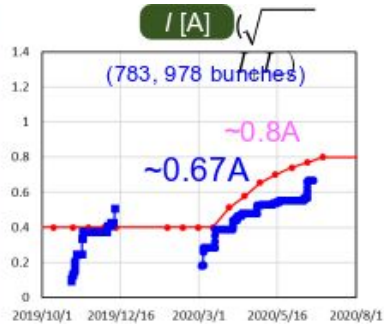
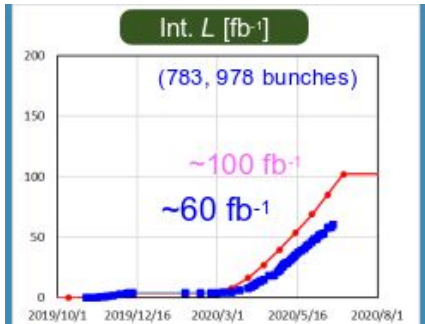
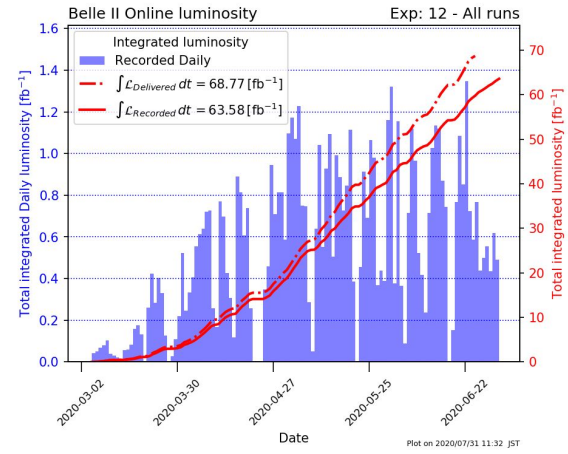
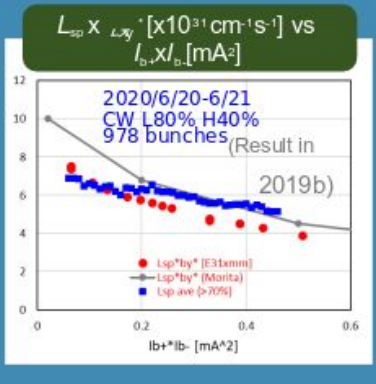
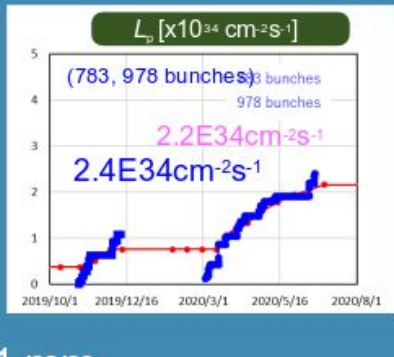
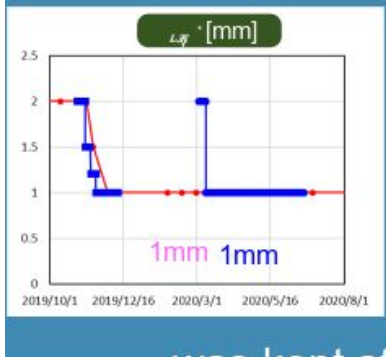

★  $L_{\text{day max}} = 1.32 \text{ fb}^{-1}$  (May 31)  
★  $L_{\text{peak}} = 2.4 \times 10^{34} \text{ cm}^{-2} \text{ s}^{-1}$  w/ Belle II ON

*Luminosity world record !*

Run 2020c started on monday - expected 60 /fb before X-mas

# BelleII Highlight fisica

Branching ratio and CP asymmetry in charmless B decays (TS), first measurements presented at winter conferences and updated for ICHEP



## Flavour tagger (TS)

Look at B-factories legacy book

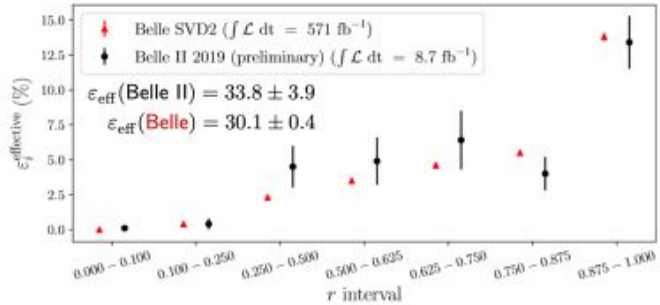

⇒ Performance comparable with best one of Belle.

D0 lifetime  
Resolution better than BaBar and Belle

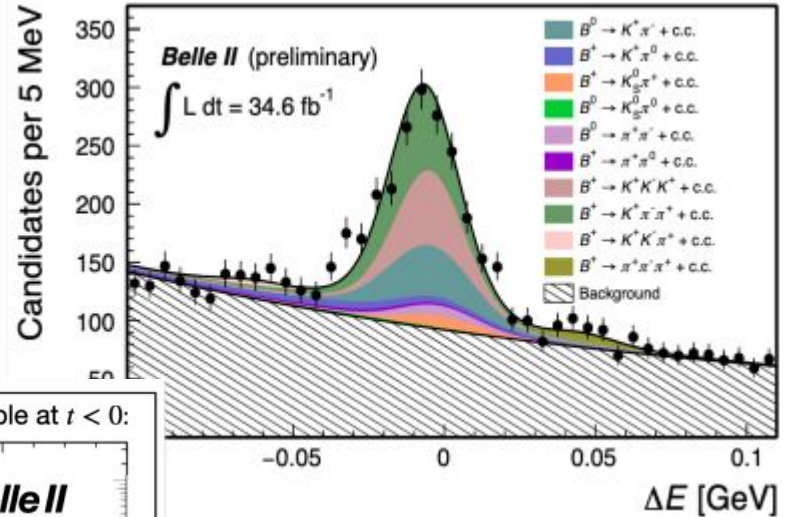

• resolution improvement visible at  $t < 0$ :

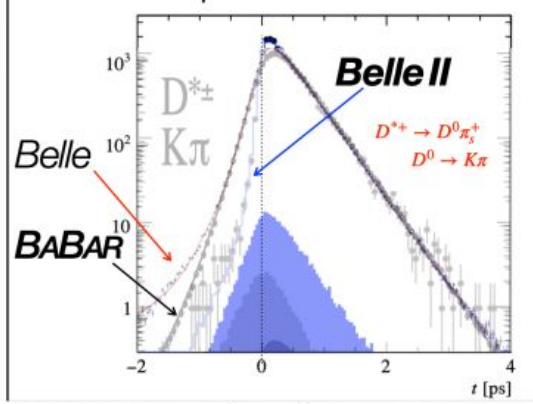

# UPGRADE DI BELLE2: CONSIDERAZIONI GENERALI

F.Cossutti: Referee BelleII

- Il raggiungimento dei  $50 \text{ ab}^{-1}$  non è più un obiettivo del 2025, ma del 2031
  - L'orizzonte temporale del goal di fisica si sposta di ~6 anni nel futuro
- Per conseguirlo, è necessario un **upgrade del rivelatore nel 2026** che permetta di estenderne la vita di altri 5-6 anni in ambiente ad alta luminosità
  - Tempi stretti per la definizione e realizzazione
- Ricevute varie proposte di contributo italiano su singoli sottorivelatori
  - Che si vanno a sommare al contributo già dato all'upgrade dei fotorivelatori del TOP, ed al cantiere sempre aperto dell'SVD beam monitoring
- **Riteniamo opportuno che la Collaborazione italiana definisca per tempo il perimetro del futuro coinvolgimento in questo upgrade di concerto con la CSN1**
  - E che sia chiaro il tetto di spesa che questo implica
  - Prima di discutere "goccia-a-goccia" uno stillicidio di proposte
  - Es. Possiamo/vogliamo essere simultaneamente coinvolti in upgrade di SVD, KLM, ECL e contribuire a vari nuovi sistemi di monitor di radiazione?

## FCC project milestones for the next 20 years

### Infrastructure and Machine

### Physics, Experiments, Detectors

(exact dates to be discussed in the coming months)

Milestone / activity	Target date	Possible timeline
First e <sup>+</sup> e <sup>-</sup> collisions in FCC-ee	2040	FCC-ee detector commissioning
Start machine installation	2037	Start FCC-ee detector installation
Tunnel completion	2035/36	
Start tunnel construction	2030	Start FCC-ee detector construction
Project approval	2028	FCC-ee Detector TDR's and approvals
Next ESPPU	2026/27	
Key prototypes (feasibility proof)	2025/26	FCC-ee Proto-collaborations and LoI's
CDR++/TDR (feasibility proof)	End 2025	CDR++ (Common work) Physics, Software, Technologies, R&D

### Sviluppi e piani per rivelatori di IDEA

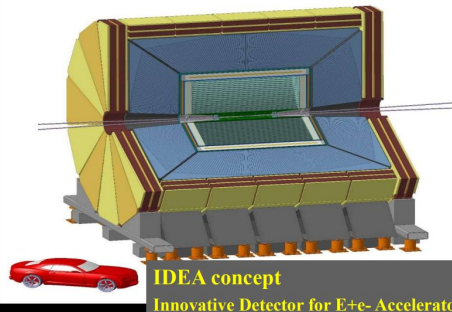

Silicio (TO/MI)  
DC (BA/LE)  
DualRO Calo  
(BO,CT,MI,PI,PV)  
PreShower/Muon  
(BO,FE,LNF,TO)

### ❖ FCC-IS – The Future Circular Collider Innovation Study.

➤ This INFRARED Research and Innovation Action project receives funding from the European Union's H2020 Framework Programme under grant agreement no. 951754

■ INFN partecipa con LNF – M. Boscolo responsabile scientifico

➤ Kick-off workshop: CERN Nov. 9-13, 2020 →

■ 4th FCC Physics and Experiments Workshop → fisici INFN nell' IPAC

### ❖ Cresce lo sforzo sul software per FCCee

➤ Sviluppo software comune per tutti i potenziali futuri colliders e+e- Key4HEP

■ Potenziato gruppo CERN

➤ Riorganizzazione gruppi di fisica per affrontare lista di "case studies"

■ Coordinatori generali (Physics Performance Coordinators): Patrizia Azzi, Emmanuel Perez

### ❖ The 2020 International Workshop on the High Energy Circular Electron Positron Collider, Shanghai 26-28 Ottobre 2020

➤ Fisici INFN nel Scientific Program Committee

### ❖ IDEA e' concetto di detector ormai "established"

➤ Default nella simulazione DELPHES del CERN

➤ Presentato ad ICHEP 2020 (anche ARCADIA, DC,  $\mu$ Rwell, ...)

### ❖ Contributi al disegno acceleratore su MDI (Boscolo/Bacchetta)

❖ **Comincia un intenso lavoro di studi software stimolato dal CERN e noi ci siamo pienamente**

❖ **R&D sui rivelatori va completato nei prossimi 3-4 anni per potere essere competitivi alla presentazione delle LoI**

## Tentative Timeline - September 2020

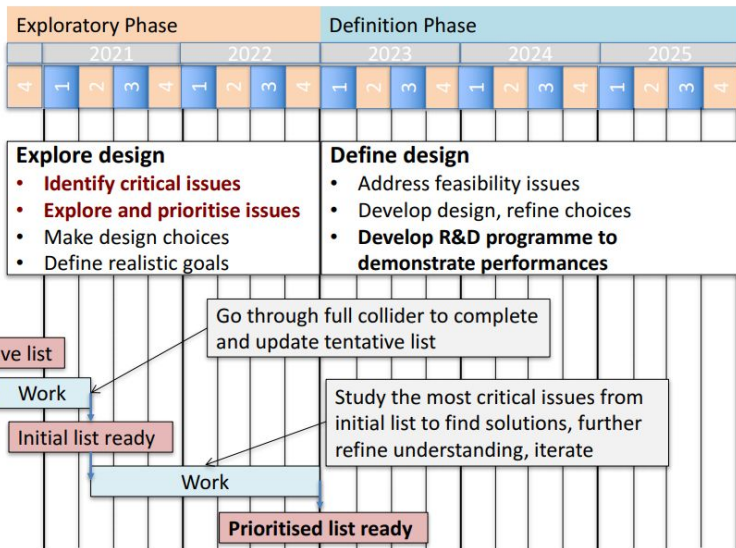

### Deliverable:

Report assessing muon collider potential and describing R&D path to CDR

### Scope:

- Focus on two energy ranges:
  - 3 TeV, if possible with technology ready for construction in 10-20 years
  - 10+ TeV, with more advanced technology
- Physics benchmarks steer machine parameters and experiment design
- Explore synergy with other options (neutrino/Higgs factory)
- Define R&D path

## Hbb @ 1.5 TeV

D. Lucchesi et al.

$\mu^+\mu^- \rightarrow H\nu\bar{\nu} \rightarrow b\bar{b}\nu\bar{\nu}$  + beam-induced background fully simulated

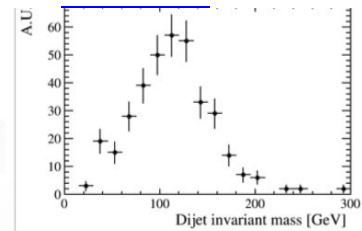

### Higgs $b\bar{b}$ Couplings Results

The instantaneous luminosity,  $\mathcal{L}$ , at different  $\sqrt{s}$  is taken from MAP. The acceptance,  $A$ , the number of signal events,  $N$ , and background,  $B$ , are determined with simulation.

$\sqrt{s}$ [TeV]	$A$ [%]	$\epsilon$ [%]	$\mathcal{L}$ [ $\text{cm}^{-2}\text{s}^{-1}$ ]	$\mathcal{L}_{int}$ [ $\text{ab}^{-1}$ ]	$\sigma$ [fb]	$N$	$B$	$\frac{\Delta\sigma}{\sigma}$ [%]	$\frac{\Delta\mathcal{R}_{Hbb}}{\mathcal{R}_{Hbb}}$ [%]
1.5	35	15	$1.25 \cdot 10^{34}$	0.5	203	5500	6700	2.0	1.9
3.0	37	15	$4.4 \cdot 10^{34}$	1.3	324	33000	7700	0.60	1.0
10	39	16	$2 \cdot 10^{35}$	8.0	549	270000	4400	0.20	0.91

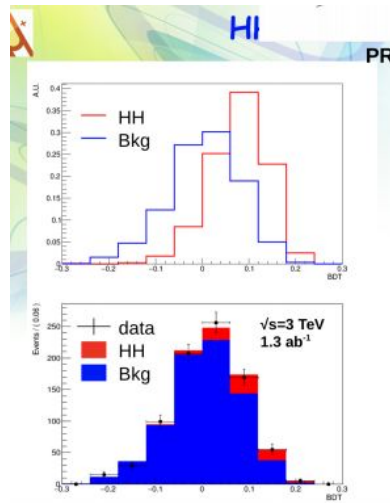

## H(bb)H(bb) @ 3 TeV

Lorenzo Sestini @ ICHEP 2020

With  $1.3 \text{ ab}^{-1}$  (4 years of data taking) at 3 TeV we expect to select **67 HH events and 745 background events.**

With a simple fit to the BDT → **An uncertainty of 33% on the cross section has been obtained.**

# Studies

**Demand for CPU and disk space**  
**10 keu @ PD T2 if possible to be assigned in 2020**

10k events $\mu\mu \rightarrow \nu\nu H(\rightarrow bb)$	10k events $\mu\mu \rightarrow \nu\nu H(\rightarrow \mu\mu)$	10k events $\mu\mu \rightarrow \nu\nu H(\rightarrow \gamma\gamma)$
10k events $\mu\mu \rightarrow \nu\nu HH(\rightarrow bbbb)$	10k events $\mu\mu \rightarrow \nu\nu H(\rightarrow ee)$	10k events $\mu\mu \rightarrow \nu\nu H(\rightarrow cc)$
10k events $\mu\mu \rightarrow \nu\nu HHH(\rightarrow bbbbbb)$	10k events $\mu\mu \rightarrow \nu\nu H(\rightarrow \tau\tau)$	10k events $\mu\mu \rightarrow \nu\nu HH(\rightarrow WW^*bb)$
10k events $\mu\mu \rightarrow \nu\nu H(\rightarrow WW^*(ZZ^*)\rightarrow \mu\mu X)$		

January 2021                      July 2021 (Snowmass)                      December 2021+2022

## Test Beam @ CERN

- Experimentally measure the key parameters of the LEMMA approach
  - Emittance of emerging  $\mu$  beam
  - $\mu^+\mu^-$  production cross-section at threshold
  - properties of spent  $e^+$  beam (transverse emittance and energy spectrum)
  - Effect of the target material/thickness
- Although these are theoretically known and can be obtained from simulations, **precise measurements do not exist at the  $\mu^+\mu^-$  production threshold**
  - GEANT does not include e.g. near-threshold Coulomb enhancements, and has not been experimentally tested in this regime

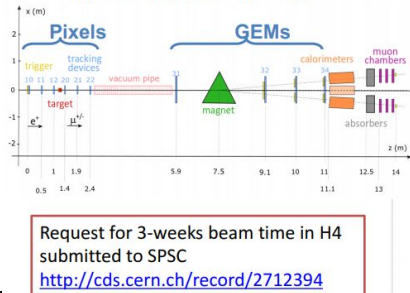

CERN-SPSC-2020-004

LEMMA-TB: an experiment to measure the production of a low emittance muon beam

N. Amarian<sup>1,3</sup>, M. Antonelli<sup>1</sup>, F. Amili<sup>1</sup>, N. Bacchetta<sup>1</sup>, N. Bartosik<sup>1</sup>, M. Bance<sup>1</sup>, A. Bertolin<sup>1</sup>, M. Bianco<sup>1</sup>, C. Blum<sup>1</sup>, O. R. Blanco-Garcia<sup>1</sup>, M. Boscolo<sup>1</sup>, A. Braglini<sup>1</sup>, A. Cappata<sup>1</sup>, F. Casali<sup>1,2</sup>, M. Casarà<sup>1</sup>, G. Casotti<sup>1,2</sup>, N. Charitonidis<sup>1,2</sup>, A. Colake<sup>1</sup>, F. Collamati<sup>1</sup>, G. Cotto<sup>1,2</sup>, D. Creanza<sup>1</sup>, C. Curatolo<sup>1</sup>, N. Deelen<sup>1</sup>, F. Gonella<sup>1</sup>, S. Hoh<sup>1,2</sup>, M. Iafrafi<sup>1</sup>, F. Iacoangeli<sup>1</sup>, B. Kian<sup>1</sup>, D. Luchessa<sup>1</sup>, V. Mascagna<sup>1</sup>, S. Merzi<sup>1</sup>, A. Paccagnella<sup>1,2</sup>, S. Pastore<sup>1</sup>, J. Pazini<sup>1,2</sup>, M. Pellegrino<sup>1</sup>, B. Penzo<sup>1</sup>, M. Pesa<sup>1</sup>, C. Riccardi<sup>1,2</sup>, M. Ricci<sup>1</sup>, R. Rossin<sup>1</sup>, M. Rotondo<sup>1</sup>, P. Salvini<sup>1</sup>, O. Sans Pineda<sup>1,2</sup>, L. Seixas<sup>1</sup>, L. Silvestri<sup>1</sup>, A. Triossi<sup>1</sup>, I. Va'ra<sup>1</sup>, E. Vallazza<sup>1</sup>, R. Venditti<sup>1</sup>, S. Ventura<sup>1</sup>, P. Verwilligen<sup>1</sup>, P. Vitulo<sup>1,2</sup>, and M. Zanetti<sup>1,2</sup>

## Challenge: Neutrino Radiation Hazard

Neutrinos from decaying muons can produce showers just when they exit the earth

Particularly bad in direction of straights  
 But also an issue in the arcs

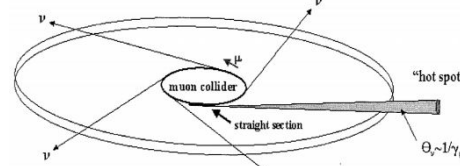

Potential mitigation by

- Site choice
- Owning the land in direction of experimental insertion
- Having a dynamic beam orbit so it points in different directions at each turn in the arcs
  - Or at least paint the beam in the the straights to dilute radiation

More important at higher energies (scaling  $E^3$ )  
 US study concluded: 6 TeV parameters are OK  
 Reasonable goal 0.1 mSv/ year, to be verified

On-going simulations and studies for mitigation with existing/future tunnels

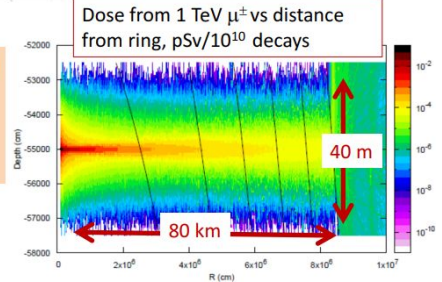

- 10 keuro su PD da anticipare al 2020 (OK referee del calcolo)
- Abbiamo espresso perplessita' sull'uso massiccio della full simulation in questa fase del progetto e alla fine consigliato una riduzione del numero di eventi da simulare

## Test beam LEMMA

- PD
- "Sistema avanzato DAQ a 40 MHz con link GBT": 20 k€ → OK
- Missioni: Integrazione al CERN: 3 k€ → 1.5 k€ SJ a progetto definitivo

Referee:



# CSN1



- Prossima riunione a 19-20 Novembre a Frascati
  - in presenza se possibile