

**AFG3000 Series
Arbitrary/Function Generators
Quick Start User Manual**

Copyright © Tektronix. All rights reserved. Licensed software products are owned by Tektronix or its subsidiaries or suppliers, and are protected by national copyright laws and international treaty provisions.

Tektronix products are covered by U.S. and foreign patents, issued and pending. Information in this publication supercedes that in all previously published material. Specifications and price change privileges reserved.

TEKTRONIX and TEK are registered trademarks of Tektronix, Inc.

Contacting Tektronix

Tektronix, Inc.
14200 SW Karl Braun Drive
P.O. Box 500
Beaverton, OR 97077
USA

For product information, sales, service, and technical support:

- In North America, call 1-800-833-9200
- Worldwide, visit www.tektronix.com to find contacts in your area.

Warranty 16

Tektronix warrants that the product will be free from defects in materials and workmanship for a period of three (3) years from the date of original purchase from an authorized Tektronix distributor. If the product proves defective during this warranty period, Tektronix, at its option, either will repair the defective product without charge for parts and labor, or will provide a replacement in exchange for the defective product. Batteries are excluded from this warranty. Parts, modules and replacement products used by Tektronix for warranty work may be new or reconditioned to like new performance. All replaced parts, modules and products become the property of Tektronix.

In order to obtain service under this warranty, Customer must notify Tektronix of the defect before the expiration of the warranty period and make suitable arrangements for the performance of service. Customer shall be responsible for packaging and shipping the defective product to the service center designated by Tektronix, shipping charges prepaid, and with a copy of customer proof of purchase. Tektronix shall pay for the return of the product to Customer if the shipment is to a location within the country in which the Tektronix service center is located. Customer shall be responsible for paying all shipping charges, duties, taxes, and any other charges for products returned to any other locations.

This warranty shall not apply to any defect, failure or damage caused by improper use or improper or inadequate maintenance and care. Tektronix shall not be obligated to furnish service under this warranty a) to repair damage resulting from attempts by personnel other than Tektronix representatives to install, repair or service the product; b) to repair damage resulting from improper use or connection to incompatible equipment; c) to repair any damage or malfunction caused by the use of non-Tektronix supplies; or d) to service a product that has been modified or integrated with other products when the effect of such modification or integration increases the time or difficulty of servicing the product.

THIS WARRANTY IS GIVEN BY TEKTRONIX WITH RESPECT TO THE PRODUCT IN LIEU OF ANY OTHER WARRANTIES, EXPRESS OR IMPLIED. TEKTRONIX AND ITS VENDORS DISCLAIM ANY IMPLIED WARRANTIES OF MERCHANTABILITY OR FITNESS FOR A PARTICULAR PURPOSE. TEKTRONIX' RESPONSIBILITY TO REPAIR OR REPLACE DEFECTIVE PRODUCTS IS THE SOLE AND EXCLUSIVE REMEDY PROVIDED TO THE CUSTOMER FOR BREACH OF THIS WARRANTY. TEKTRONIX AND ITS VENDORS WILL NOT BE LIABLE FOR ANY INDIRECT, SPECIAL, INCIDENTAL, OR CONSEQUENTIAL DAMAGES IRRESPECTIVE OF WHETHER TEKTRONIX OR THE VENDOR HAS ADVANCE NOTICE OF THE POSSIBILITY OF SUCH DAMAGES.

Table of Contents

General Safety Summary	iii
Environmental Considerations	v
Preface	vii
Documentation	vii
Conventions Used in this Manual	viii
Quick Tutorial	1
To Generate a Sine Waveform	2
Accessing Help	4
Getting Started	5
General Features	5
Before Installation	6
Operating Requirements	6
Standard Accessories	7
Recommended Accessories	8
Powering the Instrument On and Off	8
To Change Instrument Settings at Power-on	9
Self Test and Self Calibration	10
Selecting a Local Language	11
Protect Your Instrument from Misuse	12
Floating Ground	13
Protect Your DUT	14
Update Your Instrument Firmware	15
Connect to a Network	18
Equivalent Output Circuits	21
Getting Acquainted with Your Instrument	23
Front Panel Overview	23
Screen Interface	24
View Button	25
Shortcut Buttons	26
Default Setup	27
Select Waveform	28
Select Run Mode	30
Adjust Waveform Parameters	31
Channel Select (dual-channel model only)	33
Output ON/OFF	33
Rear Panel	34
Operating Basics	35
Generate a Pulse Waveform	35
Save/Recall Arbitrary Waveforms	36
Generate an Arbitrary Waveform	37
Modify an Arbitrary Waveform (Edit Menu)	38
Generate Noise/DC	41
Generate a Burst Waveform	42
Sweep a Waveform	44
Modulate a Waveform	46
Trigger Out	50
Adjusting Parameters of Two Channel Signals (dual-channel model only)	52
Set up Load Impedance	54
Invert Waveform Polarity	55

Add Noise	56
Add Signal (AFG3100 and AFG3200 Series)	57
External Reference Clock (AFG3100 and AFG3200 Series)	58
Synchronous Operation (AFG3100 and AFG3200 Series)	59
USB Memory	61
Utility Menu	62
Save/Recall Instrument Setup	64
Using the Security Menu	65
ArbExpress	67
Application Examples	73
Lissajous Patterns	73
Measurement of Filter Characteristics	74
Motor Speed Control by Pulse-Width Modulation	75
Carrier Null (Frequency Modulation)	76
Specifications	77
Electrical	77
Inputs/Outputs	82
General	83
Instrument Dimensions	84
Index	85

General Safety Summary

Review the following safety precautions to avoid injury and prevent damage to this product or any products connected to it. To avoid potential hazards, use this product only as specified.

Only qualified personnel should perform service procedures.

To avoid Fire or Personal Injury

Use Proper Power Cord. Use only the power cord specified for this product and certified for the country of use.

Ground the Product. This product is grounded through the grounding conductor of the power cord. To avoid electric shock, the grounding conductor must be connected to earth ground. Before making connections to the input or output terminals of the product, ensure that the product is properly grounded.

Observe All Terminal Ratings. To avoid fire or shock hazard, observe all ratings and markings on the product. Consult the product manual for further rating information before making connections to the product. Do not apply a potential to any terminal, including the common terminal, that exceeds the maximum rating of that terminal.

Power Off. The power cord provides Mains disconnect.

Do Not Operate Without Covers. Do not operate this product with covers or panels removed.

Do Not Operate With Suspected Failures. If you suspect there is damage to this product, have it inspected by qualified service personnel.

Do Not Operate in Wet/Damp Conditions.

Do Not Operate in an Explosive Atmosphere.

Keep Product Surfaces Clean and Dry.

Provide Proper Ventilation. Refer to the manual's installation instructions for details on installing the product so it has proper ventilation.

Symbols and Terms

Terms in this Manual. These terms may appear in this manual:



WARNING. *Warning statements identify conditions or practices that could result in injury or loss of life.*



CAUTION. *Caution statements identify conditions or practices that could result in damage to this product or other property.*

Terms on the Product. These terms may appear on the product:

DANGER indicates an injury hazard immediately accessible as you read the marking.

WARNING indicates an injury hazard not immediately accessible as you read the marking.

CAUTION indicates a hazard to property including the product.

Environmental Considerations

This section provides information about the environmental impact of the product.

Product End-of-Life Handling

Observe the following guidelines when recycling an instrument or component.

Equipment Recycling. Production of this equipment required the extraction and use of natural resources. The equipment may contain substances that could be harmful to the environment or human health if improperly handled at the product's end of life. In order to avoid release of such substances into the environment and to reduce the use of natural resources, we encourage you to recycle this product in an appropriate system that will ensure that most of the materials are reused or recycled appropriately.



The symbol shown to the left indicates that this product complies with the European Union's requirements according to Directive 2002/96/EC on waste electrical and electronic equipment (WEEE). For information about recycling about options, check the Support/Service section of the Tektronix Web site (www.tektronix.com).

Mercury Notification. This product uses an LCD backlight lamp that contains mercury. Disposal may be regulated due to environmental considerations. Please contact your local authorities or, within the United States, the Electronics Industries Alliance (www.eiae.org) for disposal or recycling information.

Restriction of Hazardous Substances

This product has been classified as Monitoring and Control equipment, and is outside the scope of the 2002/95/EC RoHS Directive. This product is known to contain lead, cadmium, mercury, and hexavalent chromium.



Preface

This manual describes the installation and operation of Tektronix AFG3000 Series Arbitrary/Function Generators along with basic operations and concepts. For more detailed information, see the Reference Manual. The following instruments are supported by this manual:

AFG3021B	AFG3022B	AFG3101
AFG3102	AFG3251	AFG3252

Documentation

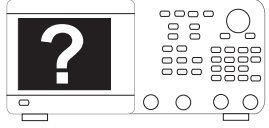
The following table lists related documentation available for your arbitrary/function generator. The documentation is available on the Document CD and on the Tektronix Web site (www.tektronix.com/manuals).

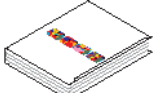
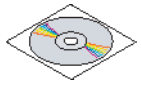
Item	Purpose	Location
Quick Start User Manual	Unpacking, Installation, Specification, Operation, and Overviews	
Built-in Help	UI Help and Operation	
Reference Manual	Menu Structures, User Interface, and Programming Information	
Service Manual (Optional)	Self-service and Performance test	
ArbExpress Software CD	Waveform creation Import waveforms from oscilloscope or PC	

Conventions Used in this Manual

The following icons are used throughout this manual.

Front panel
power



Connect
power

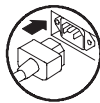

Network

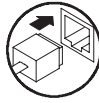

USB

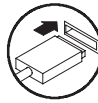

The soft keys along the right side of the display are called bezel buttons in this manual. In other documents, they may also be called option buttons or side-menu buttons.

Quick Tutorial

The quick tutorial shows beginning users how to generate a simple sine waveform. Follow these steps to get acquainted with the basics of the instrument:

1. Turn on the arbitrary/function generator.
2. Connect the CH1 Output of the arbitrary/function generator and the oscilloscope input with a BNC cable.
3. Select a waveform.
4. Enable the signal output.
5. Observe a waveform displayed on the oscilloscope screen.
6. Use the front-panel shortcut buttons to select a waveform parameter.
7. Select Frequency as a parameter to be changed.
8. Change the frequency value using numeric keys.
9. Change the waveform parameters using the general purpose knob and the arrow keys.

For more task-oriented descriptions of basic operation, see *Application Examples* on page 73.

In addition to the quick tutorial for generating a sine waveform, this section describes how to access the help system of the arbitrary/function generator.

To Generate a Sine Waveform

The following quick tutorial describes how to generate a continuous sine waveform using Tektronix AFG3000 Series Arbitrary/Function Generators. Follow these steps to learn the basics of the arbitrary/function generator.

1. Connect the power cord, and then push the front-panel power on/off switch to turn on the arbitrary/function generator.
2. Connect a BNC cable from the CH1 Output of arbitrary/function generator to an oscilloscope input connector.

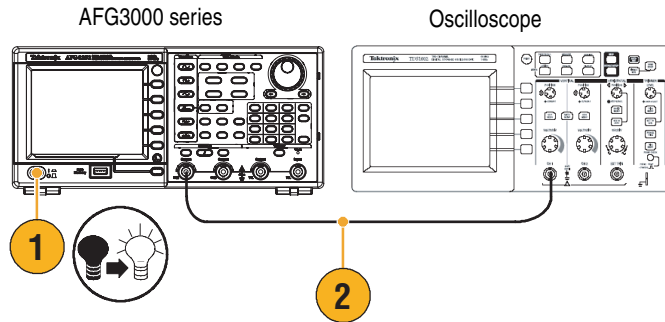

3. Push the front-panel **Sine** button, and then push the **Continuous** button to select a waveform.

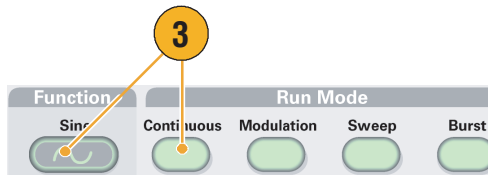

4. Push the front-panel CH1 Output **On** button to enable the output.

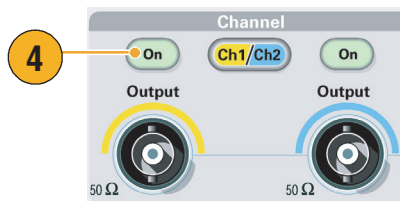

5. Use the oscilloscope auto-scaling function to display the sine waveform on the screen.

If the instrument outputs a default sine waveform, you can manually set the oscilloscope as follows:

- 0.5 μ s/div
- 200 mV/div

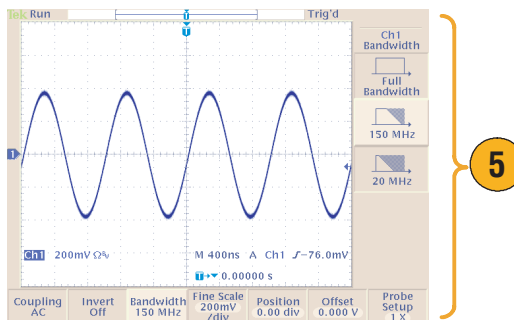

6. To change the frequency, push the front-panel **Frequency/Period** short-cut button.

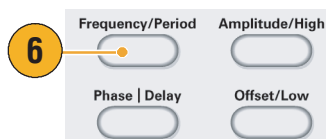

7. The Frequency/Period/Phase Menu is displayed and **Freq** is selected. You can now change the frequency value.

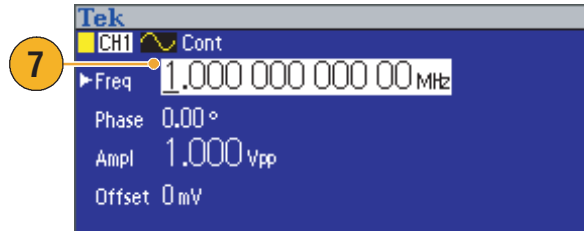

8. To change the frequency value, use the keypad and Units bezel buttons.

For example, if you enter a value "2" using the keypad, the bezel menu will automatically change to Units.

After entering the frequency value, push the Units bezel button or the front-panel **Enter** button to complete the entry.

You can change the Amplitude, Phase, and Offset values in the same way.

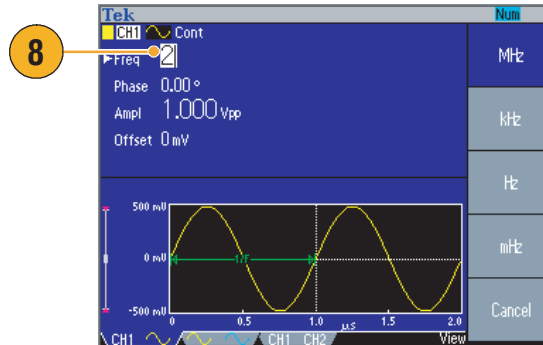

9. You can also change the frequency value using the general purpose knob and the arrow keys.

To increase the value, turn the knob clockwise.

To change a specific digit, select it by pushing the arrow keys. Then change it by turning the knob.



Quick Tips

- Use the front-panel shortcut buttons to quickly select a waveform parameter. See page 26 for usage of shortcut buttons.
- You can also specify a waveform parameter by using bezel menu selection. This method does not use the front-panel shortcut buttons.
- When you specify a waveform parameter using the shortcut buttons or bezel menu selection, an active parameter is displayed in green in the graph area. (See step 8 above.)

Accessing Help

1. Push the front-panel **Help** button to display the help screen.
2. Most of the help topics contain phrases marked with <angle brackets>. These are links to other topics. Turn the general purpose knob to move the high-light from one link to another.
3. Push the **Show Topic** bezel button to display the topic corresponding to the highlighted link.
4. Push the **Index** bezel button to display an Index page.
5. Push the **Exit** bezel button or any front-panel button to remove the Help text from the screen and return to the graphic or parameter display.

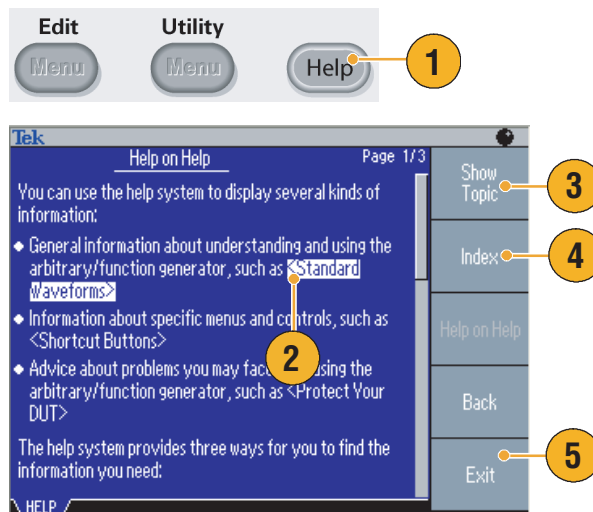

Quick Tips

- When you push the **Help** button, the instrument displays information about the last menu displayed on the screen. If the topic uses more than one page, turn the general purpose knob to move from page to page within the topic.
- Push the front-panel **Help** button, and then push the **Index** bezel button to display an Index page. Push the **Page Up** or **Page Down** bezel button until you find the index page that contains the topic you want to view. Turn the general purpose knob to highlight a help topic. Push the **Show Topic** button to display the topic.
- You can select the language of the bezel menus and Help information. See page 11.

Getting Started

General Features

The following table and list describe the general features of AFG3000 Series Arbitrary/Function Generators.

Model	AFG3021B/AFG3022B	AFG3101/AFG3102		AFG3251/AFG3252	
Channel	1/2	1/2		1/2	
Sine	25 MHz	100 MHz		240 MHz	
Pulse	12.5 MHz	50 MHz		120 MHz	
Memory	2 to 131,072	2 to 16,384	>16,384 to 131,072	2 to 16,384	>16,384 to 131,072
Sampling Rate	250 MS/s	1 GS/s	250 MS/s	2 GS/s	250 MS/s
Amplitude	10 V _{p-p}	10 V _{p-p}		5 V _{p-p}	
Display	Monochrome/Color	Color		Color	
Interface	USB, LAN, GPIB	USB, LAN, GPIB		USB, LAN, GPIB	

- Three functions integrated into one generator:
 - 25 MHz to 240 MHz Function Generator
 - 12.5 MHz to 120 MHz Pulse Generator
 - 14 bits Arbitrary Waveform Generator
- Color or monochrome LCD display
- Ground isolation
- Synchronous operation
- USB memory interface
- ArbExpress[®] Software
- Context-sensitive Help system

Before Installation

Inspect the arbitrary/function generator carton for external damage. If the carton is damaged, notify the carrier.

Remove the arbitrary/function generator from its package and check that it has not been damaged in transit. Verify that the carton contains the instrument and its standard accessories. Refer to *Standard Accessories* on page 7.

Operating Requirements

Environmental

1. Place the instrument on a cart or bench, observing clearance requirements:
 - Sides: 50 mm (2 in)
 - Rear: 50 mm (2 in)
2. Before operating, ensure that the ambient temperature is between 0 °C to +50 °C (+32 °F to +122 °F).

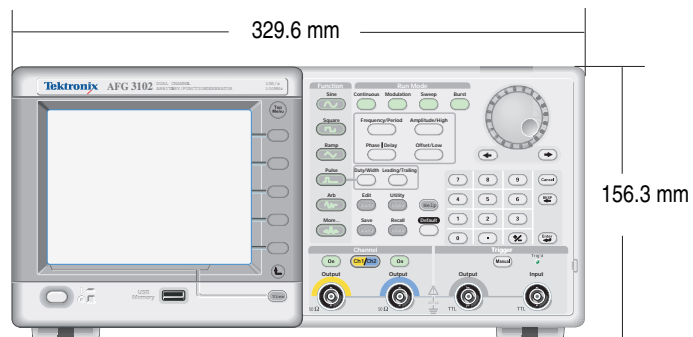

CAUTION. To ensure proper cooling, keep both sides of the instrument clear of obstructions.

Power Supply Requirements

Source Voltage and Frequency	100 V to 240 V, 47 Hz to 63 Hz or 115 V, 360 Hz to 440 Hz
Power Consumption	Less than 120 W

Standard Accessories

Unpack the instrument and check that you received all items listed as Standard Accessories. Check the Tektronix Web site (www.tektronix.com) for the most current information.

Accessory	Tektronix part number
AFG3000 Series Arbitrary/Function Generators Quick Start User Manual	
English (Option L0)	071-1631-xx
French (Option L1) ¹	071-1632-xx
Italian (Option L2)	071-1669-xx
German (Option L3) ¹	071-1633-xx
Spanish (Option L4)	071-1670-xx
Japanese (Option L5) ¹	071-1634-xx
Simple Chinese (Option L7) ¹	071-1635-xx
Traditional Chinese (Option L8) ¹	071-1636-xx
Korean (Option L9) ¹	071-1637-xx
Russian (Option L10) ¹	071-1638-xx
No printed manual (Option L99)	---
AFG3000 Series Document CD	063-3828-xx
ArbExpress (Application Software for Tektronix Arbitrary/ Function Generators) Software CD	063-3763-xx
AFG3000 Series Arbitrary/Function Generators Reference Manual (a PDF file on the AFG3000 Series Document CD)	071-1639-xx
AFG3000 Series Arbitrary/Function Generators Service Manual (a PDF file on the AFG3000 Series Document CD)	071-1640-xx
Power cord	
North America (Option A0)	161-0066-00
Universal Euro (Option A1)	161-0066-09
United Kingdom (Option A2)	161-0066-10
Australia (Option A3)	161-0066-13
Switzerland (Option A5)	161-0154-00
Japan (Option A6)	161-0298-00
China (Option A10)	161-0304-00
No power cord or AC adapter (Option A99)	---

1. These manuals contain a language overlay for the front panel controls.

Recommended Accessories

The following optional accessories are recommended for your instrument:

- 50 Ω BNC cable, double-shielded, 91 cm (36 in) (Tektronix part number 012-0482-00)
- 50 Ω BNC cable, double-shielded, 250 cm (98 in) (Tektronix part number 012-1256-00)
- GPIB interface cable, double-shielded, 2 m (Tektronix part number 012-0991-00)

NOTE. To ensure the EMC compliance listed in the Specifications, connect only high quality shielded cables to this instrument. High quality shielded cables typically are braid and foil types that have low impedance connection to shielded connectors at both ends.

- RM3100 Rackmount kit (see page 84 for dimensions of the kit)
- Fuse adapter (see page 12 for more information)

Powering the Instrument On and Off

Power On

1. Insert the AC power cord into the power receptacle on the rear panel.

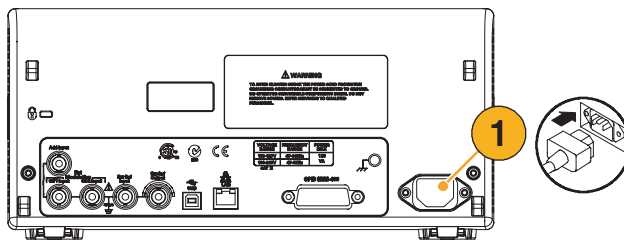

2. Use the front-panel power button to power on the instrument.
Wait until the front panel display shows that the instrument has passed all power-on self tests.



Power Off

1. Use the front-panel power button to power off the instrument.

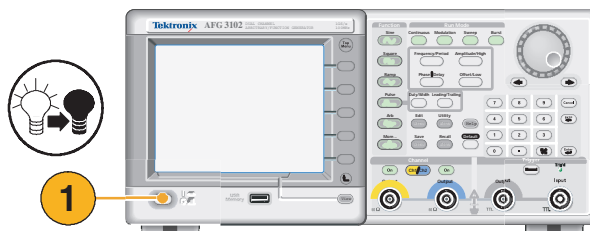

To Change Instrument Settings at Power-on

The default settings are restored when you power on the instrument. You can change the power-on settings to the last powered-off settings. Use the **Utility** menu to change the power-on settings.

1. Push the front-panel **Utility** button.
2. Push the **System** bezel button.

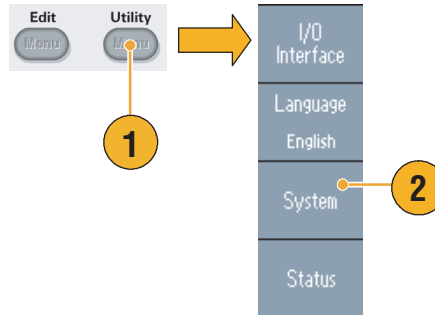

3. Push the **Power On** bezel button to select the power on settings.
 - **Default**
Select Default to restore the default settings when the instrument is powered on.
 - **Last**
Select Last to restore the same settings as when the instrument was last powered off.

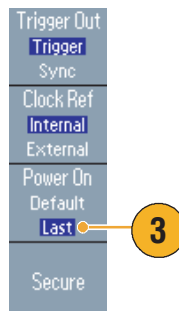

Quick Tips

- You can restore the instrument to its default settings at any time by pushing the front-panel **Default** button.
- To restore the factory default settings, push the front-panel **Utility** > **System** bezel > **Secure** bezel buttons. Executing the secure function will erase all the instrument setups and waveforms stored in the internal memory.

NOTE. When you set the power-on settings to Last, it is important to keep in mind that sometimes the instrument might not output signals the next time you power on, depending on the instrument settings. For example, if Burst is selected as the Run Mode and external trigger source is selected, the instrument will not output signals without receiving a trigger signal.

Self Test and Self Calibration

The arbitrary/function generator performs a limited set of hardware tests at power-on. You can also perform the manual diagnostics and/or self calibration using the **Utility** menu.

- Diagnostics (Self test) – Perform the self test to verify that your instrument is operating correctly.
- Calibration (Self calibration) – The self calibration mainly checks DC accuracy using the internal calibration routines.

NOTE. If you need to verify that the instrument meets the warranted specifications, do the complete set of performance verification procedures provided in the Service Manual.

1. Push the front-panel **Utility** button.
2. Push the **-more-** bezel button.
3. Push the **Diagnostics/Calibration** bezel button.

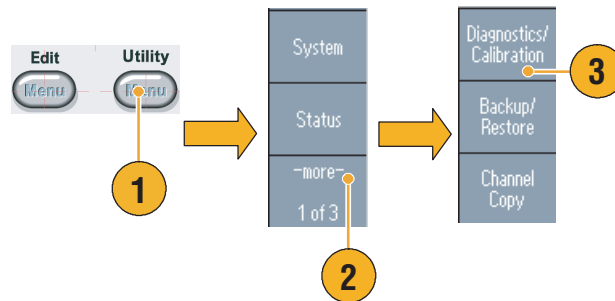

4. To execute the instrument diagnostics, push the **Execute Diagnostics** bezel button.
To execute self calibration, push the **Execute Calibration** bezel button.
5. If Diagnostics completes without any errors, the message "PASSED" is displayed.

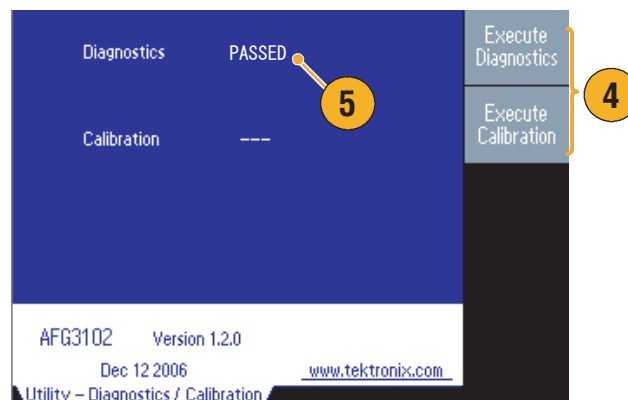

CAUTION. Do not power off the instrument while executing self calibration. If the power is turned off during self calibration, data stored in the internal memory may be lost.

Quick Tips

- Before executing self calibration, ensure that the ambient temperature is between +20 °C and +30 °C (+68 °F to +86 °F). Allow a 20 minute warm-up period before executing self calibration.
- Perform self calibration at least once a year to maintain DC accuracy. It is recommended that the self calibration should be performed along with a periodic check.

Selecting a Local Language

You can select a language to display on the instrument screen.

1. Push the front-panel **Utility** button.

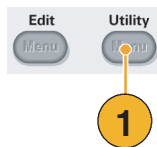

2. Push the **Language** bezel button.

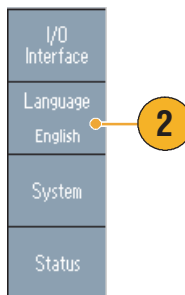

3. Select the desired language.

You can select from English, French, German, Japanese, Korean, Simple Chinese, Traditional Chinese, and Russian.



Quick Tips

- When you power on the instrument for the first time, English is selected by default. After you select a desired language, all the bezel menus, pop-up messages, and built-in help are displayed in the specified language. The main display area (see page 24) is not translated.
- Use the front panel overlay that corresponds to each local language.

Protect Your Instrument from Misuse

Check Input and Output Connectors

1. The instrument has both input and output connectors on the front panel.

When connecting a cable, be sure to distinguish the input connector from the output connectors.

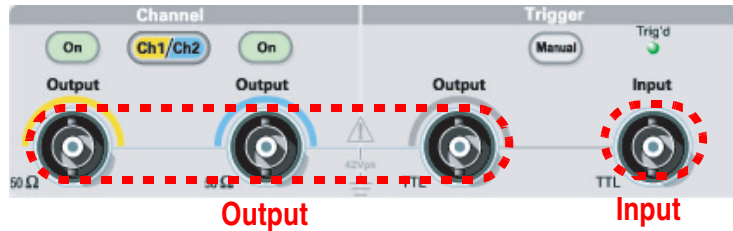

Do not mistake Output connectors for Input.

The arbitrary/function generator input and output connectors are floating inputs/outputs.



WARNING. To prevent electrical shocks, do not apply voltages in excess of 42 Vpk to any BNC connector ground or to the chassis ground.



CAUTION. Do not short output pins or apply external voltages to Output connectors. The instrument may be damaged.



CAUTION. Do not apply excessive inputs over +5 V to Trigger Input connector. The instrument may be damaged.

Use Fuse Adapter

The instrument will be damaged if a large DC or AC voltage is applied to the output or input connectors. To protect the output circuits, a fuse adapter is provided as an optional accessory. When the instrument is used by students or other inexperienced users, always attach the fuse adapter to the output connectors to avoid damage.

Tektronix part numbers for the fuse adapter are as follows:

- 013-0345-00: Adapter
- 159-0454-00: 0.125 A fuse set (3 each)

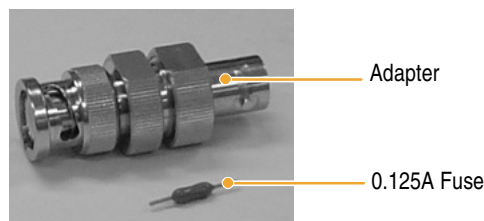

Floating Ground

Since the common (input and output channel common) of the arbitrary/function generator is electrically isolated from the chassis ground (the instrument chassis and ground line of the AC connector), you can make a floating connection between the instrument and other equipment.

All the signal output connectors are connected to the common ground, and the remote interface connector is connected to the chassis ground.



CAUTION. When you make a floating connection, review the following precautions:

The maximum rated voltage between the chassis ground and common ground is $42 V_{p-p}$ (DC + peak AC). When the potential voltage between the chassis ground and common ground goes over $42 V_{p-p}$, the internal protective circuit will be activated to protect the circuits. However, higher voltage may cause the internal circuits in the instrument to be damaged.

When a potential voltage exists between the chassis ground and common ground, a short circuit from output to ground causes the instrument internal fuse to open and the output is stopped. If the fuse opens, you need to contact your local Tektronix Service Support.

When a potential voltage exists between the common ground and chassis ground, short-circuiting between them may lead to excessive current flow and the internal or external circuits may be damaged.

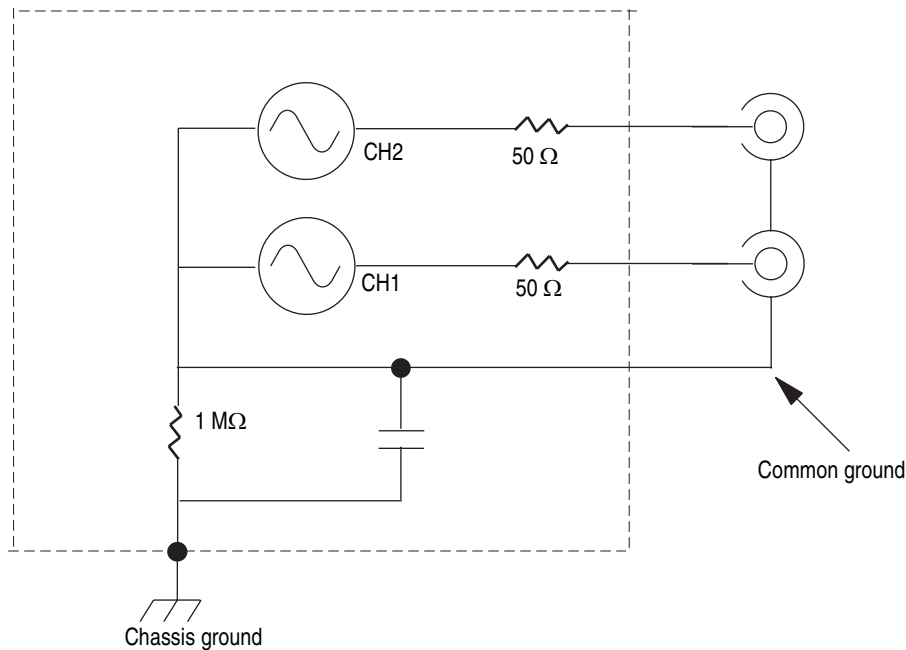

Protect Your DUT

Use care when you connect the instrument Channel Output to your DUT (device under test). To avoid damage to your DUT, the following preventive measures are provided. Follow these steps to set the limit values for high level and low level.

1. Push the front-panel Top Menu  button. The **Output Menu** is displayed at the bottom of the bezel menu. Select **Output Menu**.

2. In this example, High Limit is set to 5.000 V, and Low Limit is set to -5.000 V.

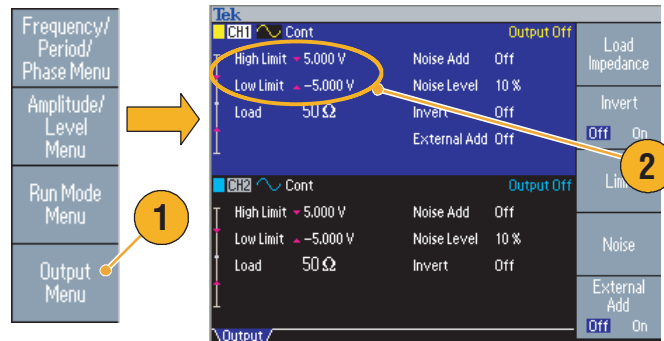

3. Push the **Limit** bezel button.

4. Select **High Limit**. Use numeric keys or the general purpose knob to enter a value.

Enter 50 mV for High Limit, and -50 mV for Low Limit.

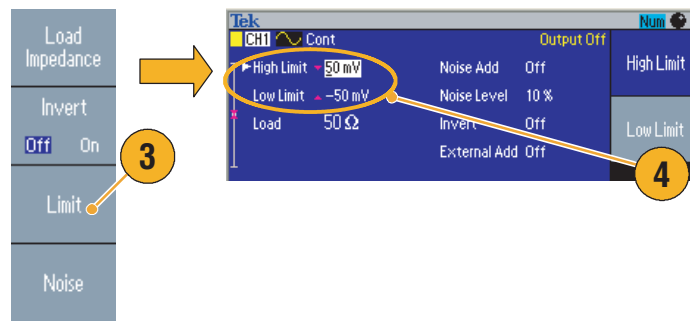

5. Push the front-panel **Sine** button to display the waveform parameter. Confirm that High and Low voltage levels were changed.

You cannot enter any values greater than 50 mV for High level.

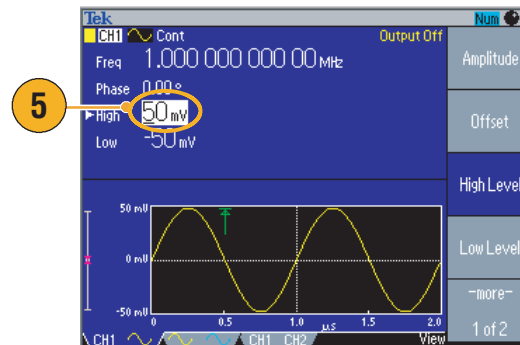

Quick Tip

- When you set limit values using Output Menu, a level indicator is displayed at left end of graph area. Refer to *Screen Interface* on page 24 for the level indicator.

Update Your Instrument Firmware

You can use the front-panel USB memory connector to update your arbitrary/function generator firmware.



CAUTION. Updating your instrument firmware is a sensitive operation which may damage your instrument if you do not follow all instructions carefully. To prevent damage to the instrument, do not remove the USB memory or power off the instrument during the update process.

NOTE. The screen images of the following procedure are provided as an example. The actual screen display may be different depending on your instrument configuration.

1. Push the front-panel **Utility** button to display the Utility menu.

Version information is displayed on the screen. Confirm the firmware version of your instrument.

2. Visit www.tektronix.com, and check if Tektronix offers a newer firmware version. Download the compressed zip file with the most current firmware to your PC.

Unzip the downloaded file and copy the file to your USB memory.

3. Insert the USB memory into the front-panel USB connector.

4. Push the **-more-** bezel button twice in the Utility menu.
5. The third page of the Utility menu is displayed. Select **Firmware Update**.

Note. If the USB memory is not inserted, the **Firmware Update** bezel button is disabled.

Note. If **Access Protection** is on, the **Firmware Update** bezel button is disabled. See page 65 for **Access Protection**.

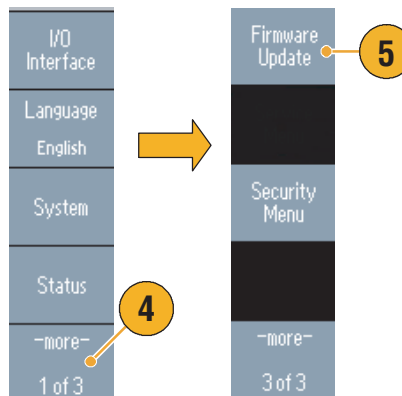
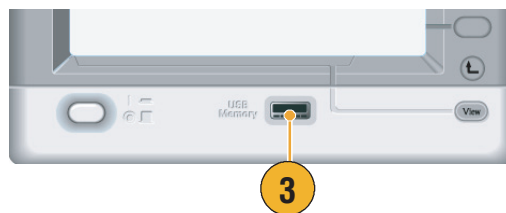
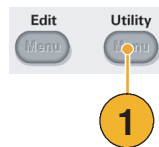

6. Select the downloaded firmware file by rotating the general purpose knob, and then push the **Execute** bezel button.

The firmware file name is as follows:

- tekafgtb-1.x.x.tfb

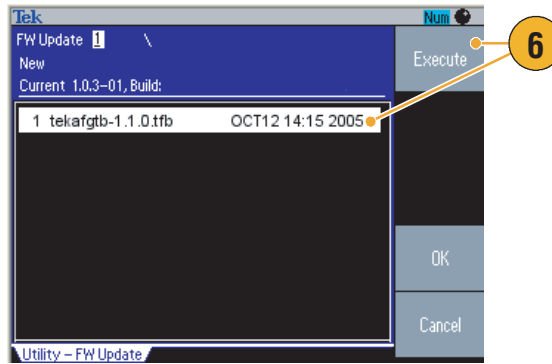

7. The instrument asks you "**Are you sure you want to update firmware?**". Push **OK**.

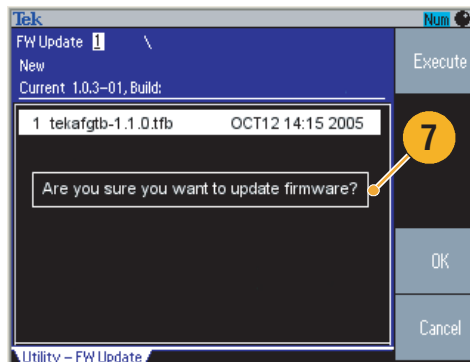

8. The instrument displays "**Do not power off until the process completes.**" The clock symbol at the top right of the screen indicates the update process is in progress.

CAUTION. A firmware update usually takes approximately two minutes. Do not remove the USB memory during the update process.

CAUTION. If you accidentally removed the USB memory during the update process, do not power off the instrument. Repeat the installation process from step 3.

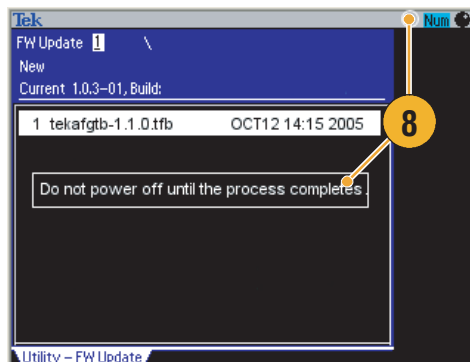

9. Wait until the instrument displays "**Operation completed.**"

10. Push **OK**.

CAUTION. If "Operation completed" is not displayed, do not power off the instrument. Repeat the installation process from step 2 using a different type of USB memory.

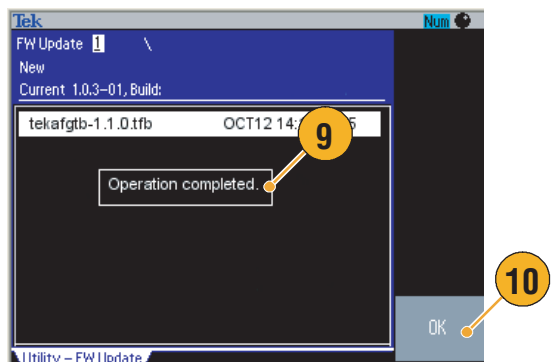

11. Remove the USB memory from the front-panel USB connector.
12. Power the instrument off and then back on.
13. Push the front-panel **Utility** button to display the Utility menu.
Confirm that the firmware has been updated.

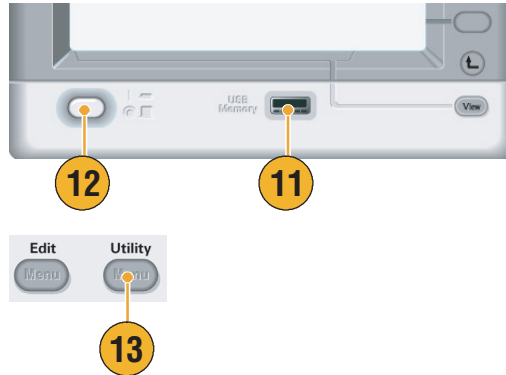

Quick Tip

- You can protect access to firmware update using the Security menu. See page 65.

Connect to a Network

The AFG3000 series arbitrary/function generator communication interface allows you to communicate with or remotely control your instrument. You can use a USB, Ethernet, or GPIB interface.

USB Interface

The USB interface requires no front panel or bezel menu operations to set up. Use a USB cable to connect your instrument to a PC.

Ethernet Setup

To connect your instrument to a network, you must first obtain information from your network administrator. The procedure for entering the Ethernet network parameters depends on your network configuration. If your network supports DHCP (Dynamic Host Configuration Protocol), follow these steps:

1. Connect a LAN cable to the LAN port on the rear panel.

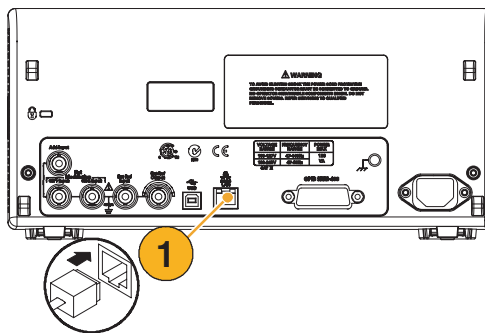

2. Push the front-panel **Utility** button.

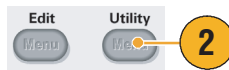

3. Push the **I/O Interface > Ethernet** bezel buttons.

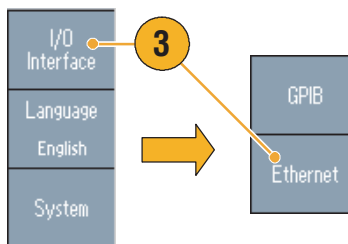

4. The Ethernet Network Settings menu is displayed.

By selecting the DHCP **On**, the instrument can set its network address automatically through DHCP.

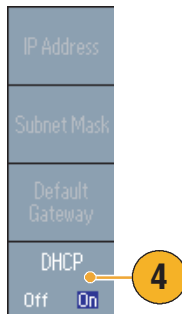

If you cannot establish communication by setting DHCP On, you need to set up an IP Address manually and a Subnet Mask if necessary. Follow these steps:

5. Display the Ethernet Network Settings menu and select DHCP **Off**.
6. Push the **IP Address** bezel button to enter an IP address. You need to contact your network administrator to get the IP address to use.
7. Push the **Subnet Mask** bezel button to enter a Subnet Mask. Ask your network administrator whether a subnet mask is required.
8. Push the **Default Gateway** bezel button to enter a gateway address. Ask your network administrator for the gateway address.

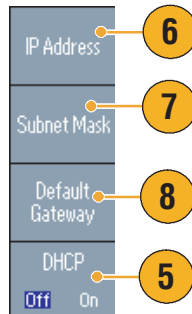

GPIB Setup

To set the instrument GPIB interface, follow these steps:

1. Connect a GPIB cable to the rear panel GPIB port.

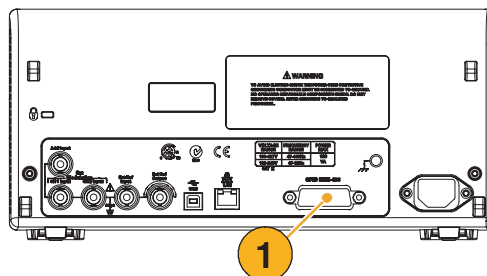

2. Push the front-panel **Utility** button.
3. Push the **I/O Interface > GPIB** bezel buttons.

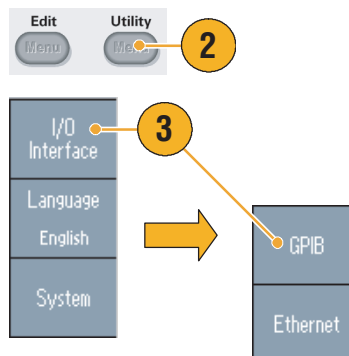

4. Push the **Address** bezel button to assign a unique address to the instrument.

The GPIB address defines a unique address for the instrument. Each device connected to the GPIB bus must have a unique GPIB address. The GPIB address must be from 0 to 30.

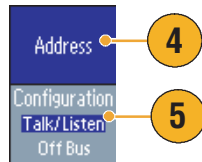

5. Push the **Configuration** bezel button to toggle the instrument bus communications on and off.
 - **Talk/Listen** – Select this mode to remotely control the instrument from an external host computer.
 - **Off Bus** – Select this mode to disconnect the instrument from the GPIB bus.

Quick Tip

- Refer to the *AFG3000 Series Arbitrary/Function Generators Reference Manual* for information on remote control commands.

Equivalent Output Circuits

The following illustrations show the equivalent output circuits for the AFG3000 series instruments:

1. AFG3021B and AFG3022B

- Amplitude and offset of the output signals are not affected by load impedance.

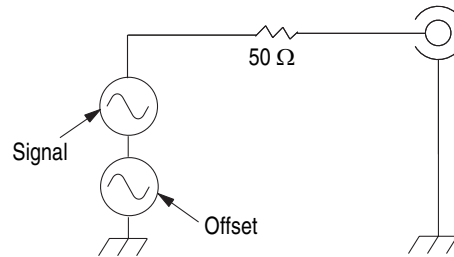

2. AFG3101/AFG3102 and AFG3251/AFG3252

- Output signals do not exceed ± 10 V when the >50 Ω load impedance is used.
- Voltage over the maximum level is clipped.
- Amplitude and offset are affected when you change the load impedance. The maximum and minimum levels do not exceed ± 10 V, respectively.

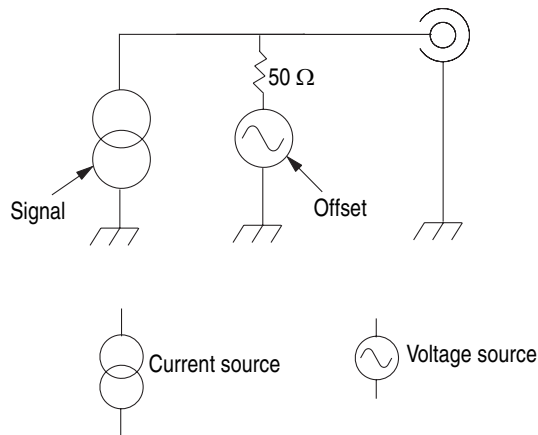

The following table shows the output window (maximum and minimum levels) for sine waveform when you change the load impedance (L). Load impedance will affect the output window. Refer to page 54 for setting up load impedance.

	L = 50 Ω	L = High Z
AFG3021B/AFG3022B		
Maximum level	5 V	10 V
Minimum level	-5 V	-10 V
(Maximum amplitude)	(10 V _{p-p})	(20 V _{p-p})
AFG3101/AFG3102		
Maximum level	10 V	10 V
Minimum level	-10 V	-10 V
(Maximum amplitude)	(10 V _{p-p})	(20 V _{p-p})
AFG3251/AFG3252		
Maximum level	5 V	10 V
Minimum level	-5 V	-10 V
(Maximum amplitude)	(5 V _{p-p})	(10 V _{p-p})

Getting Acquainted with Your Instrument

Front Panel Overview

The front panel is divided into easy-to-use functional areas. This section provides you with a quick overview of the front panel controls and the screen interface. The following figure shows the front panel of the dual-channel model.

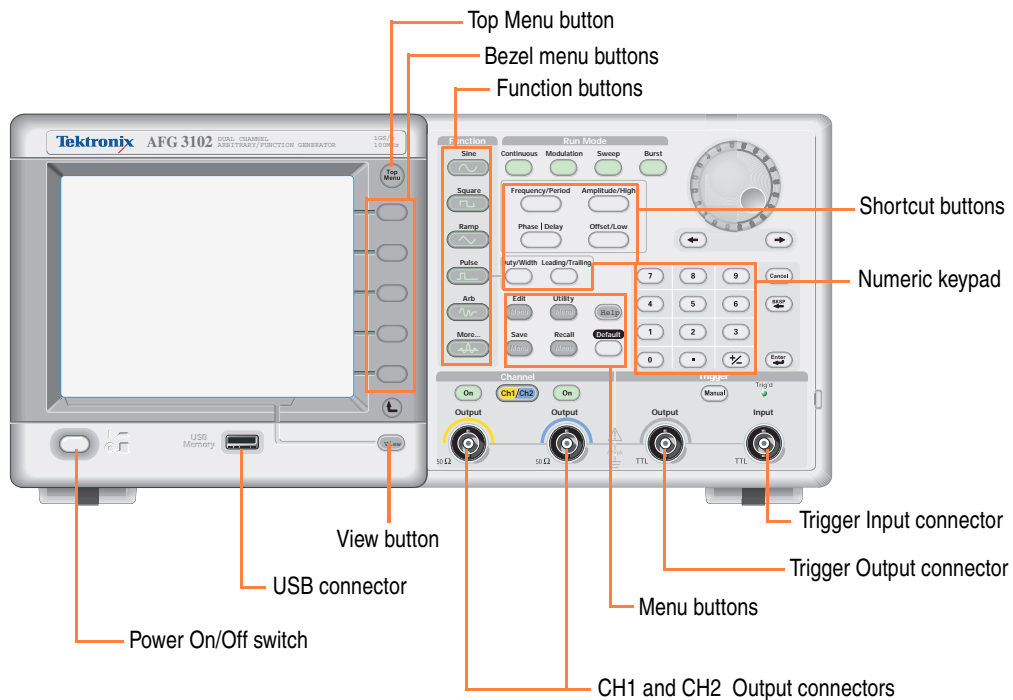

To Lock or unlock the Front Panel Controls

If you need to lock the front panel controls, use the following remote command:

- `SYSTEM:KLOCK[:STATe]`

To unlock the front panel without using a remote command, push the front-panel **Cancel** button twice.

Screen Interface

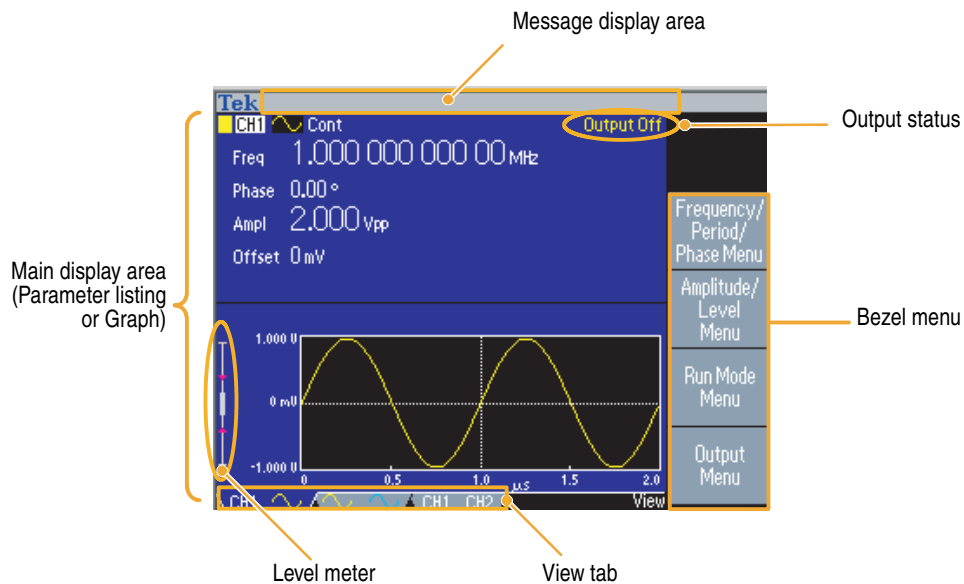

Bezel Menu. When you push a front panel button, the instrument displays the corresponding menu on the right side of the screen. The menu shows the options that are available when you push the unlabeled bezel buttons directly to the right of the screen. (Some documentation may also refer to the bezel buttons as option buttons, side-menu buttons, or soft keys.)

Main Display Area and View Tab. Pushing the front-panel **View** button toggles through the view format of the main display area. The view tabs correspond with the current view format. The arbitrary/function generator can display three different screen formats (see page 25).

Output Status. If the output is set to disable, **Output Off** message is displayed in this area. When you push the front panel channel output button (see page 33) to enable the output, the message will disappear.

Message Display Area. A message that monitors hardware status such as clock or trigger is displayed in this area.

Level Meter. Amplitude level is displayed. Refer to page 14 for setting the high limit and low limit. The following figure describes the level meter.

1. Shows maximum amplitude level of your instrument.
2. Shows the range of high limit and low limit set by the user.
3. Shows the amplitude level that is currently selected.

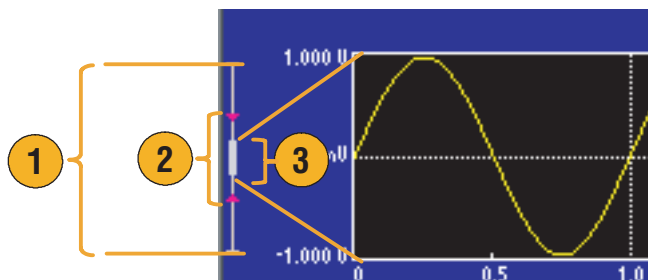

View Button

The instrument provides the following three screen view formats:

- Waveform parameter and graph display
- Graph comparison
- Waveform parameter comparison

1. To change the screen display format, push the front-panel **View** button.

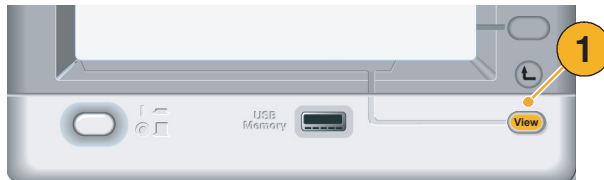

2. The first format provides the single channel waveform parameters and graph display.

(Dual-channel model only):

You can toggle the CH1 and CH2 information by pushing the channel select button (see page 33).

When you push the **View** button once, the view format is changed to the graph comparison format.

Push the **View** button again to display the third format. This view provides the channel parameter comparison.

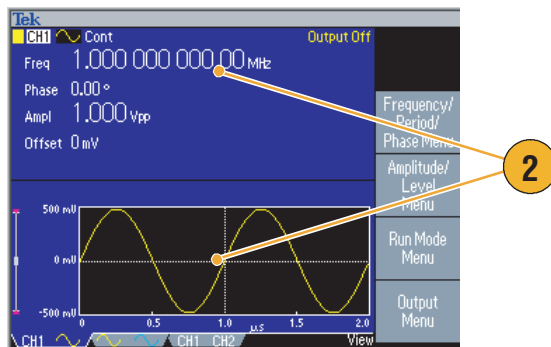

Quick Tips

- If the instrument is currently in the Save, Recall, Utility, Help, or Output menu, pushing the **View** button will have no effect.
- When the instrument is in the Edit menu, pushing the **View** button will toggle between Edit text and graphical views. This is the only function of the single-channel model view button.

Shortcut Buttons

Shortcut buttons are provided for experienced users. The shortcut buttons allow you to select a setup parameter and enter a numeric value using the front panel controls. By using the shortcut buttons, you can select a waveform parameter without using any bezel menu selection.

1. Shortcut buttons are located below the Run Mode buttons on the front panel.
In this example, use pulse waveform.

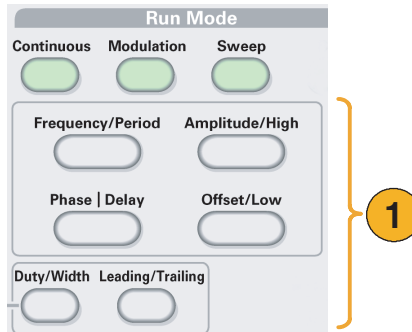

2. If you push the **Amplitude/High** shortcut button once, **Amplitude** becomes active.

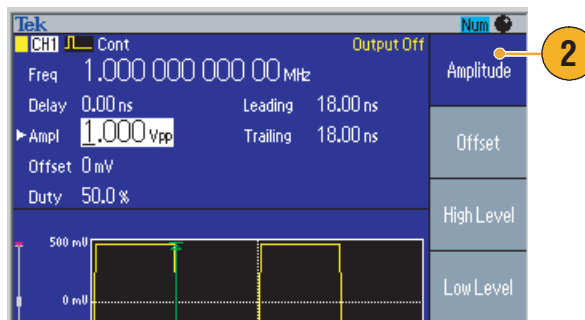

3. If you push the **Amplitude/High** shortcut button again, **High Level** becomes active.

You can also set parameters for Frequency/Period, Offset/Low, Duty/Width, or Leading/Trailing in the same way.

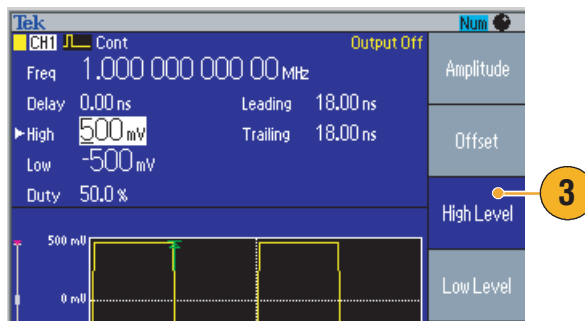

Quick Tips

- If you push the **Phase | Delay** shortcut button, **Delay** becomes active. Pushing **Phase | Delay** again will have no effect, because there is no phase parameter in the pulse parameter menu.
- The **Duty/Width** and **Leading/Trailing** shortcut buttons are functional only when the instrument is in the pulse parameter menu.

Default Setup

When you want to restore the instrument settings to the default values, use the front-panel **Default** button.

1. Push the front-panel **Default** button.



2. A confirmation pop-up message appears on the screen.
Push **OK** to recall the default settings.
Push **Cancel** to cancel the recall.

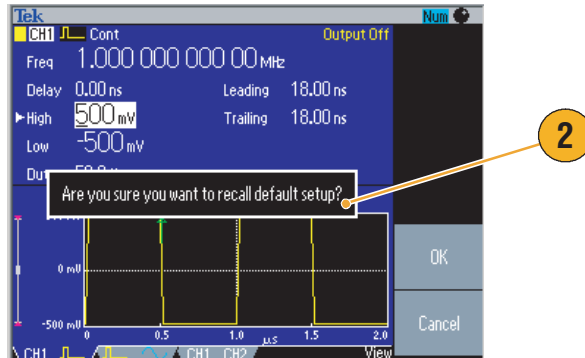

3. If you select **OK**, the instrument displays a 1 MHz frequency, 1 V_{p-p} amplitude sine waveform as the default setup.

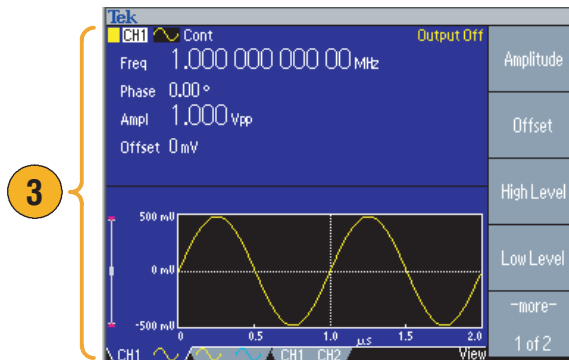

Quick Tips

- The *AFG3000 Series Arbitrary/Function Generators Reference Manual* describes the default setup settings in detail. This manual is available on the accompanying CD or at www.tektronix.com.
- The front-panel Default button does not reset the following settings:
 - Language option
 - Power-on settings
 - System related settings (display contrast, screen saver, click tone, and beeper)
 - Saved setups and arbitrary waveform data
 - Calibration data
 - GPIB and Ethernet setups
 - Access protection

Select Waveform

The instrument can provide 12 standard waveforms (Sine, Square, Ramp, Pulse, Sin(x)/x, Noise, DC, Gaussian, Lorentz, Exponential Rise, Exponential Decay, and Haversine). The instrument can also provide user-defined arbitrary waveforms. You can create, edit, and save your custom waveforms.

You can also create modulated waveforms using the Run Mode Modulation menus. The following table shows the combination of modulation type and the shape of the output waveform.

	Sine, Square, Ramp, Arb, Sin(x)/x, Gaussian, Lorentz, Exponential Rise, Exponential Decay, Haversine	Pulse	Noise, DC
AM	√		
FM	√		
PM	√		
FSK	√		
PWM		√	
Sweep	√		
Burst	√	√	

NOTE. When the arbitrary/function generator outputs an Arb waveform, V_{p-p} of instrument setup indicates the V_{p-p} value of normalized waveform data.

When the arbitrary/function generator outputs Sin(x)/x, Gaussian, Lorentz, Exponential Rise, Exponential Decay, or Haversine, V_{p-p} is defined as twice the value of 0 to peak value.

To select an output waveform, follow these steps:

1. To select a continuous sine waveform, push the front-panel **Sine** button and then push the **Continuous** button.
2. You can directly select one of four standard waveforms from the front-panel **Function** buttons.
3. To select an arbitrary waveform, push the **Arb** button. See page 37 for outputting an arbitrary waveform.
4. To select other standard waveforms such as Sin(x)/x, Noise, DC, or Gaussian, push the **More...** button, and then push the top bezel button.

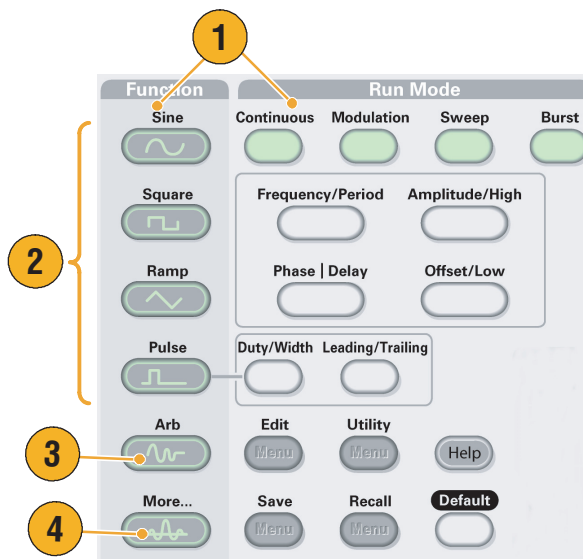

5. These are waveform examples of $\text{Sin}(x)/x$ and Noise.

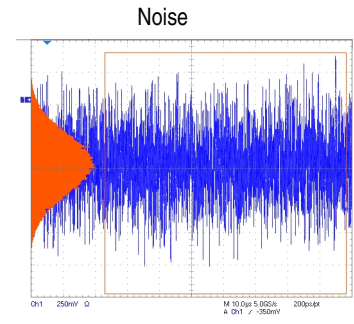
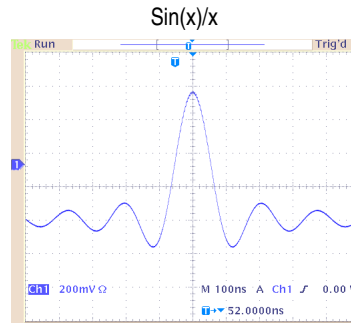

6. These are waveform examples of DC and Gaussian.

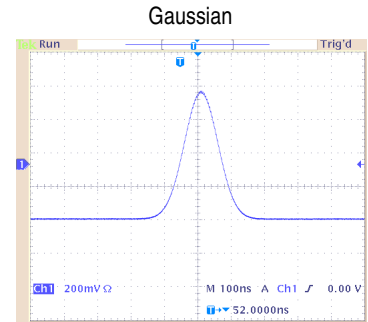
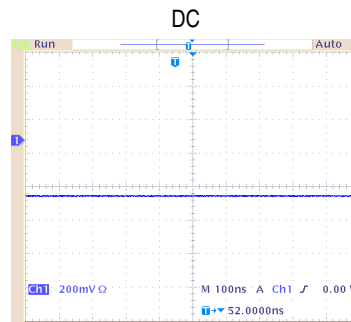

7. These are waveform examples of Lorentz and Haversine.

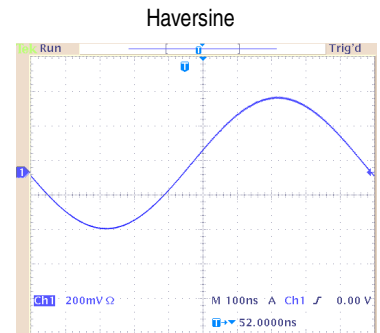
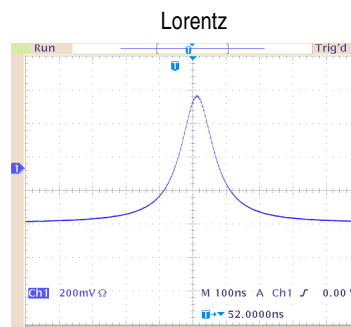

8. These are waveform examples of Exponential Rise and Exponential Decay.

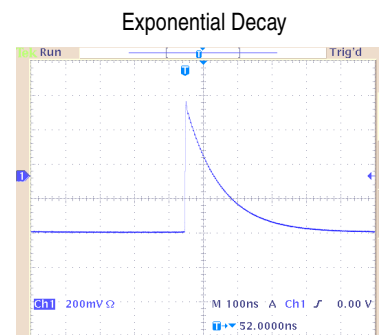
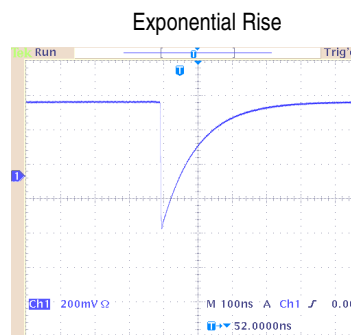

Select Run Mode

Push one of the four Run Mode buttons to select the instrument signal output method.

1. The default Run Mode is **Continuous**.

To change waveform parameters, see page 31.

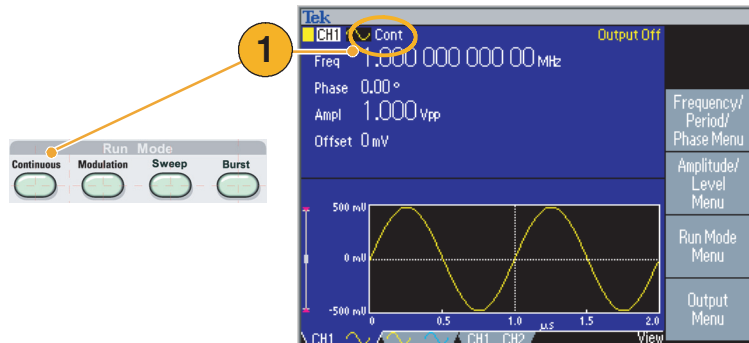

2. To select a modulated waveform, push the **Modulation** button.

See page 46 for details on modulating waveforms.

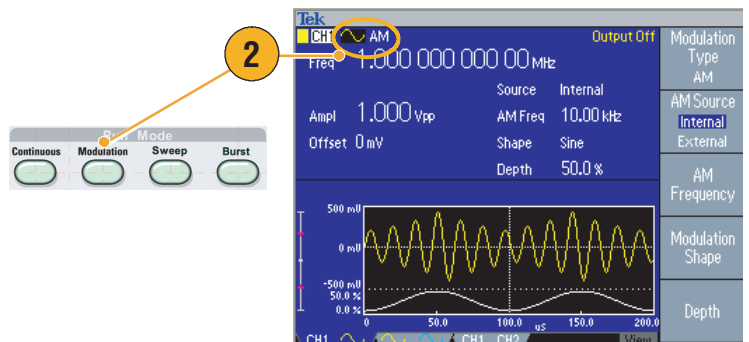

3. To select a sweep waveform, push the **Sweep** button.

See page 44 for details on sweeping waveforms.

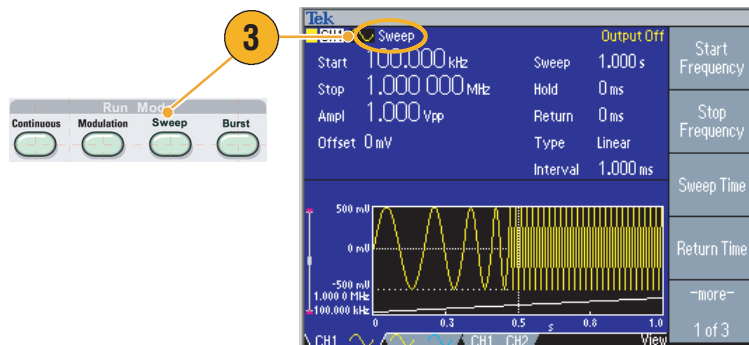

4. To select a burst waveform, push the **Burst** button.

See page 42 for details on Burst mode.

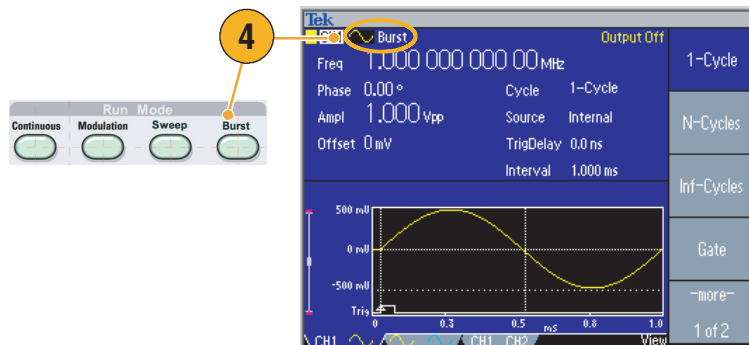

Adjust Waveform Parameters

When you turn on your instrument, the default output signal is a 1 MHz sine waveform with an amplitude of 1 V_{p-p}. In the following example, you can change the frequency and amplitude of the original output signal.

1. Push the front-panel **Default** button to display the default output signal.

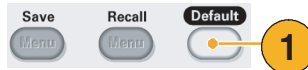

2. To change frequency, push the front-panel **Frequency/Period** shortcut button.

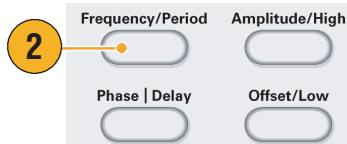

3. **Frequency** is now active. You can change the value using the keypad and Units bezel menu, or you can change the value with the general purpose knob.

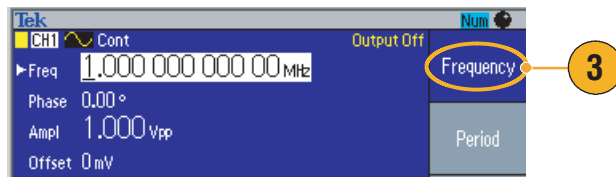

4. Push the **Frequency/Period** shortcut button again to toggle the parameter to **Period**.

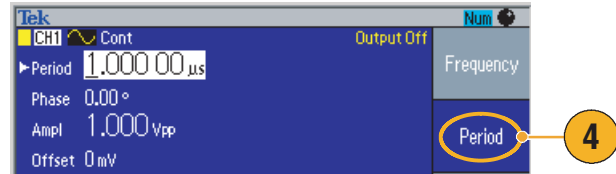

5. Next, change amplitude. Push the **Amplitude/High** shortcut button.

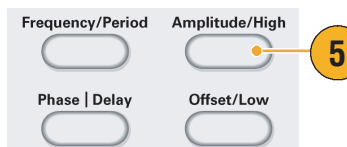

6. **Amplitude** is now active. You can change the value using the keypad and Units bezel menu, or you can change the value using the general purpose knob.

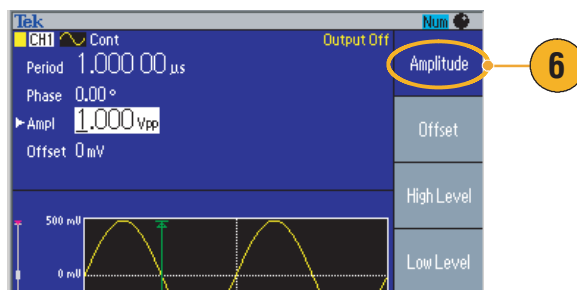

7. Push the **Amplitude/High** shortcut button again to toggle the parameter to **High Level**.

You can change the values of Phase and Offset in the same way.



8. To change the amplitude units, push the **-more-** bezel button to display the second page.
9. Push the **Units** bezel button to display units selection bezel menu. By default, **V_{p-p}** is selected.

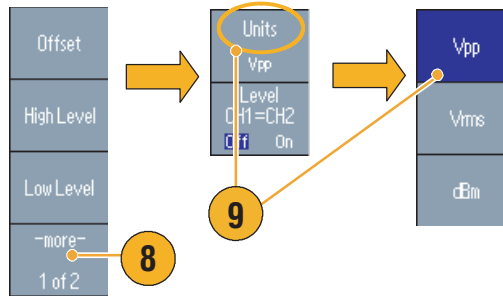

Quick Tip

The following conversion table shows the relationship between V_{p-p} , V_{rms} , and dBm.

V_{p-p}	V_{rms}	dBm
10.00 V_{p-p}	3.54 V_{rms}	+23.98 dBm
2.828 V_{p-p}	1.00 V_{rms}	+13.01 dBm
2.000 V_{p-p}	707 mV_{rms}	+10.00 dBm
1.414 V_{p-p}	500 mV_{rms}	+6.99 dBm
632 mV_{p-p}	224 mV_{rms}	0.00 dBm
283 mV_{p-p}	100 mV_{rms}	-6.99 dBm
200 mV_{p-p}	70.7 mV_{rms}	-10.00 dBm
10.0 mV_{p-p}	3.54 mV_{rms}	-36.02 dBm

Channel Select (dual-channel model only)

1. Push the front-panel **Channel Select** button to control the screen display. You can toggle between the two channels.

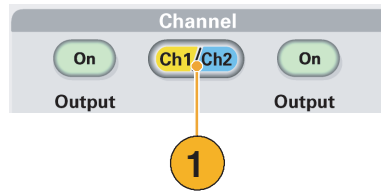

NOTE. If you push the Channel Select button while you are in the Edit, Utility, Save, Recall, or Help menu, the screen display returns to the previous view. The channels do not toggle.

Output ON/OFF

1. To enable signal output, push the front-panel Channel Output **On** button. The button is lit with an LED when it is in the On state.

You can configure the signal with the outputs off. This will allow you to minimize the chance of sending a problematic signal to a DUT.

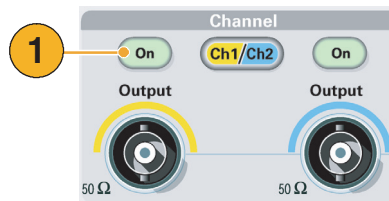

2. (Dual-channel model only) You can turn on or off the signal output for channel 1 and channel 2 independently.

You can enable one of the two channels or enable both of the two channels at any time.

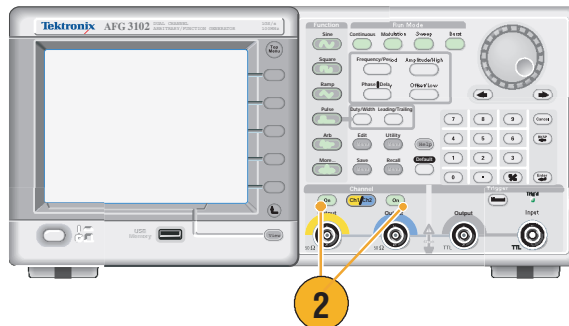

Rear Panel

The following illustration shows the rear panel connectors for the instrument.

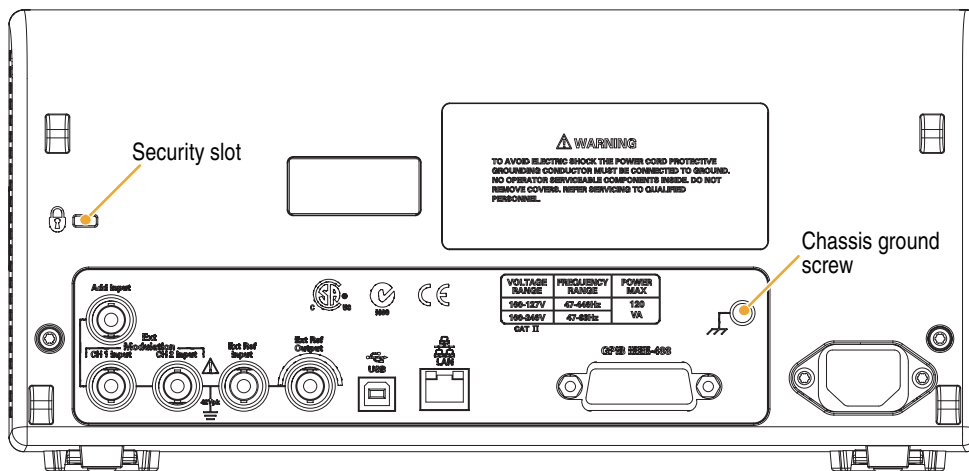

EXT REF INPUT. This is a BNC connector for the external reference input. When you want to synchronize multiple AFG3000 series arbitrary/function generators, or synchronize your arbitrary/function generator and another instrument, use the external reference input connector.

EXT REF OUTPUT. This is a BNC connector for the external reference output. When you want to synchronize multiple AFG3000 series arbitrary/function generators, or synchronize your arbitrary/function generator and another instrument, use the external reference output connector.

ADD INPUT. The ADD INPUT connector is provided with AFG3101/AFG3102 and AFG3251/AFG3252. This connector lets you add an external signal to the CH1 output signal.

EXT MODULATION INPUT (CH1 and CH2). The CH1 INPUT and CH2 INPUT are independent. The signal input level of these connectors controls modulation parameters.

USB. Used to connect a USB controller. (Type B)

LAN. Used to connect the instrument to a network. Connect a 10BASE-T or 100BASE-T cable here.

GPIB. Used to control the instrument through GPIB commands.

Security Slot. Use a standard laptop computer security cable to secure your instrument to your location.

Chassis Ground Screw. The chassis ground screw is used to ground the instrument. Use a unified coarse screw (#6-32, 6.35 mm length or less).

Operating Basics

Generate a Pulse Waveform

1. Push the front-panel **Pulse** button to display the Pulse screen.
2. Push the **Frequency/Period** shortcut button to select Frequency or Period.

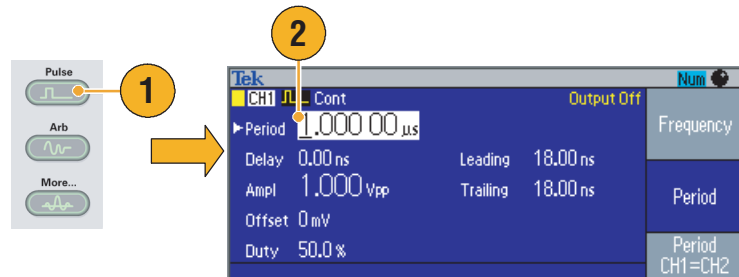

3. Push the **Duty/Width** shortcut button to toggle between Duty and Width.
4. Push the **Leading/Trailing** shortcut button to toggle the parameters for Leading Edge and Trailing Edge.

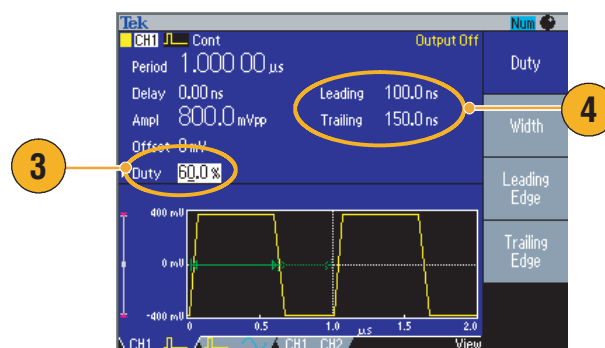

5. This is an example of a pulse waveform displayed on an oscilloscope screen.

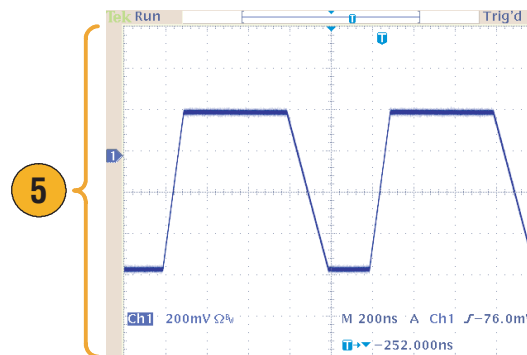

Quick Tip

- You can set Lead Delay. Push the **Phase | Delay** shortcut button to display the lead delay setting screen. You can also select **Lead Delay** from the bezel menu.

Save/Recall Arbitrary Waveforms

You can save up to four arbitrary waveforms in the instrument internal memory. To save more waveforms, use a USB memory.

1. To recall or save an arbitrary waveform, push the front-panel **Edit** button to display the Edit menu.

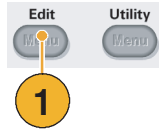

2. Select Read from... to recall an arbitrary waveform.
3. The Read Waveform page is displayed.

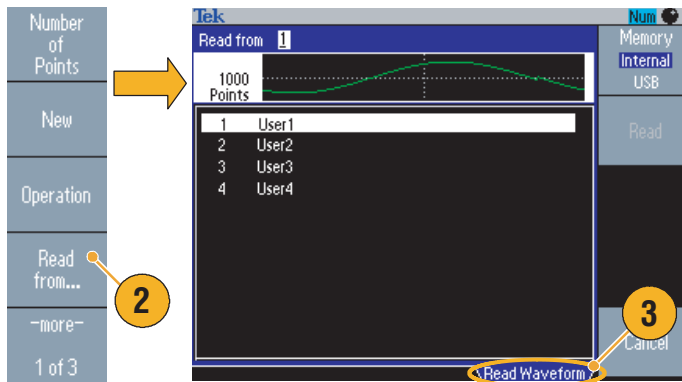

4. To save waveforms, select **Write to...** to display the Write Waveform page.
5. If you save a waveform to a USB memory, a file with the extension TFW is saved.

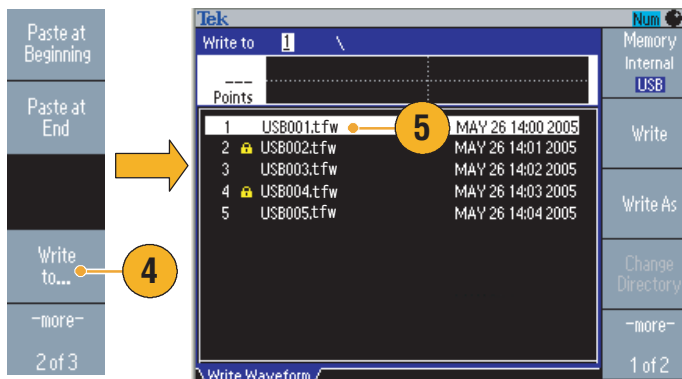

6. You can also recall waveforms by pushing the front-panel **Arb > Arb Waveform Menu** bezel buttons.

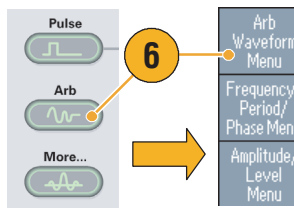

Quick Tips

- Push the **-more-** bezel button in the **Write to...** submenu to display the Lock/Unlock and the Erase menu.
- The Lock/Unlock function allows you to lock the file against accidental overwrite.

Generate an Arbitrary Waveform

The arbitrary/function generator can output an arbitrary waveform that is stored in the internal memory or a USB memory.

1. Push the front-panel **Arb** button.
2. Push the **Arb Waveform Menu** bezel button.

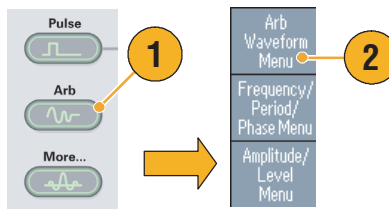

3. The Arb Waveform Menu is displayed. You can now browse a list of waveform files in the internal memory or USB memory.

Select **Internal**. You can specify a file from User 1 through User 4, or Edit Memory.

Use the front panel general purpose knob to scroll the files, then select a file and push **OK**.

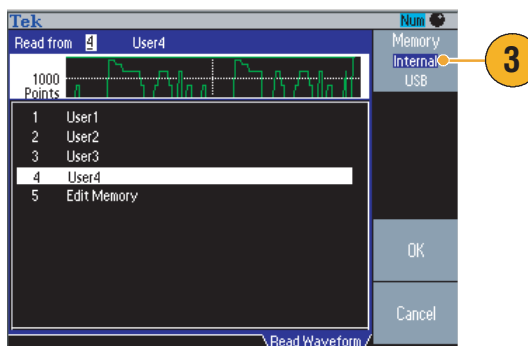

4. When **USB** is selected, the instrument lists a directory of the folders and files on the USB memory.

You can select a folder or file using the knob to scroll up and down the list. To open a folder, push the **Change Directory** bezel button. To open a file, push **OK**.

To return to the upper directory, first select the <Up Directory> icon, and then push the **Change Directory** bezel button.

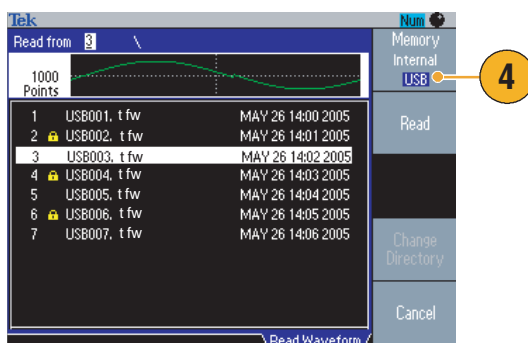

Quick Tips

- File names are displayed only in English characters. If you use non-English characters to name a file, these characters are replaced by Roman symbols such as #, \$, %.
- Use the **Write to...** bezel menu in the **Edit** menu to copy a waveform file on the USB memory to the internal memory.

Modify an Arbitrary Waveform (Edit Menu)

To modify an arbitrary waveform, use the Edit Menu. The Edit Menu supports several waveform edit functions, and provides import or storage of edited waveform data.

1. Push the front-panel **Edit** button to display the Edit Menu.



2. Select **Number of Points** to set the number of waveform points to be edited.

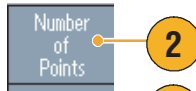

3. Select **New** to write a standard waveform to Edit memory. The written waveform has the number of points specified by **Number of Points**. One of five waveform types (Sine, Square, Ramp, Pulse, and Noise) can be selected.



4. Select **Operation** to display the Operations submenu.



5. Select **Read from...** to specify a memory location of waveform data from **Internal** or **USB**.



6. Push **Operation** to display the Operations submenu.

- Push **Line** to display the Line edit submenu.
- Push **Data** to display the Data Point edit submenu.
- Push **Cut** to display the Cut Data Points submenu.

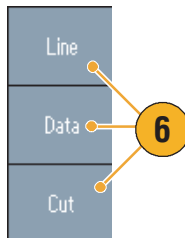

7. Select **Paste at Beginning** to append a waveform at the beginning of the edit waveform.

Select **Paste at End** to append a waveform at the end of the edit waveform.

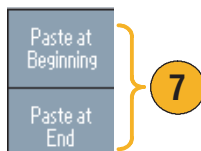

8. Select **Write to...** to display a submenu to write waveform data to.



Arbitrary Waveform Edit Example 1

The following example shows how to use the Line edit function. Paste a ramp waveform before sine waveform:

1. Select **Number of Points** to set the number of waveform points to 1000 points.
2. Select **New** and then select **Sine**. Save this waveform to User1.

For saving arbitrary waveforms, refer to page 36.

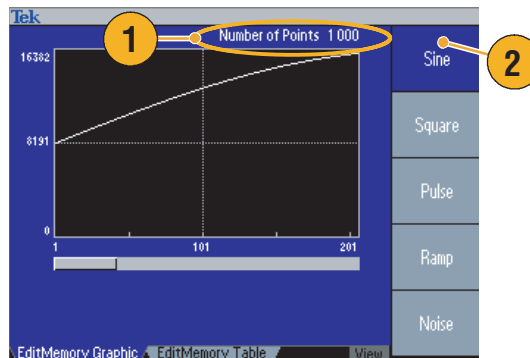

3. Next, create a 500 point ramp waveform.
4. Select **Operation** and select **Line**. Do the following line edit:
 - X1: 1, Y1: 8191
 - X2: 250, Y2: 16382

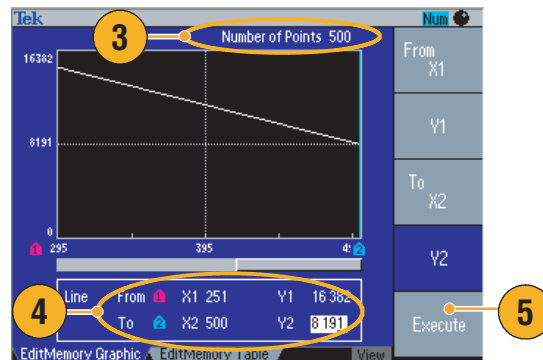

Push **Execute**. Once again, select **Line** from **Operation** and perform the following line edit:

- X1: 251, Y1: 16382
- X2: 500, Y2: 8191

5. Push **Execute**. Save this waveform to User2.
6. Next, paste a waveform. Push **Read from...** and select User1.
7. Push **Paste at Beginning**. Select User2 waveform and then select **Paste**.
8. The waveform shown here is created.

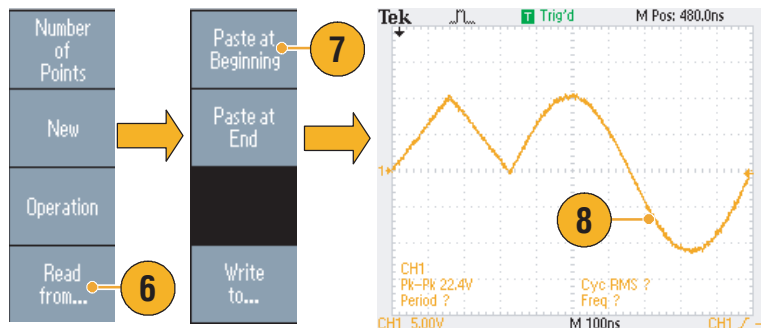

Arbitrary Waveform Edit Example 2

The following example shows how to edit a waveform by data point. In this example, you can add a noise spike to the sine waveform.

1. Push **Read from...** and select **User1**.
2. Push the front-panel **View**  button to change the screen to Table display.

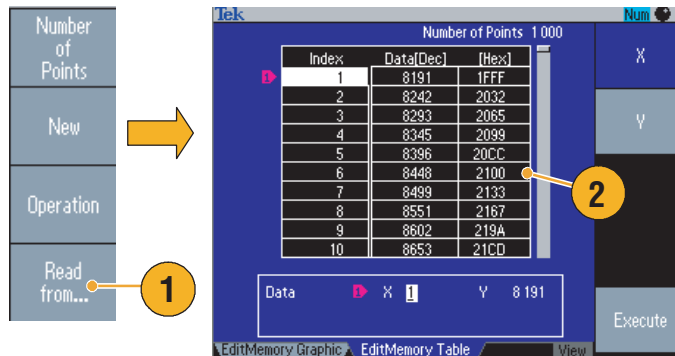

3. Push **Operation** and select **Data**.
4. Perform the following data point edit:
 - X: 250, Y: 8191
 - X: 251, Y: 8191
 - X: 750, Y: 8191
 - X: 751, Y: 8191

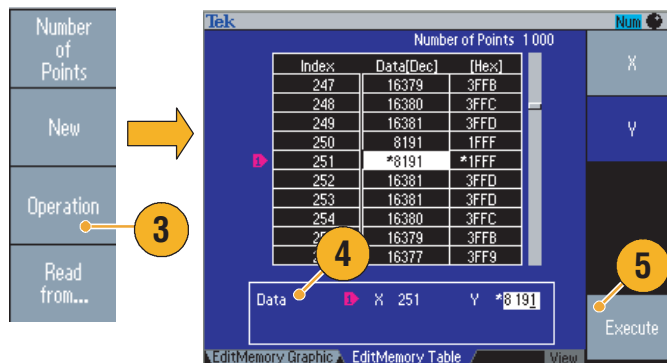

5. After each data edit, push **Execute** to implement the edit operation. Save this waveform to User3.
6. This is an example of an oscilloscope screen for the User3 waveform.

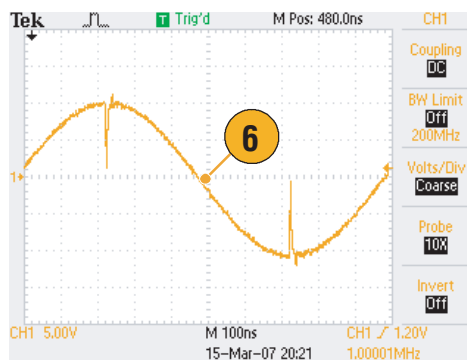

Quick Tips

- If you edit an arbitrary waveform data while the instrument generates a waveform from Edit Memory, the edited data will be automatically reflected to the generated waveform.
- Push the front-panel **View** button in the Edit Menu to toggle between edit texts and graphical views.

Generate Noise/DC

1. Push the front-panel **More...** button.
2. Push the **More Waveform Menu** bezel button.

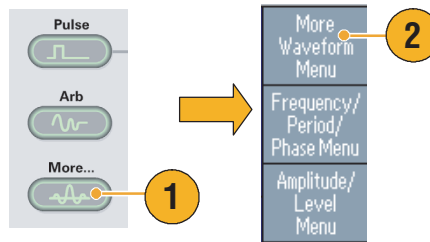

3. Select **Noise**.
4. You can set waveform parameters for Noise. This is a sample of Gaussian Noise displayed on an oscilloscope screen.

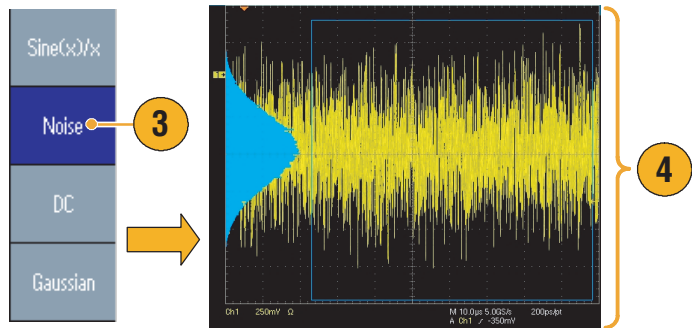

5. Push **DC** to display DC parameters.

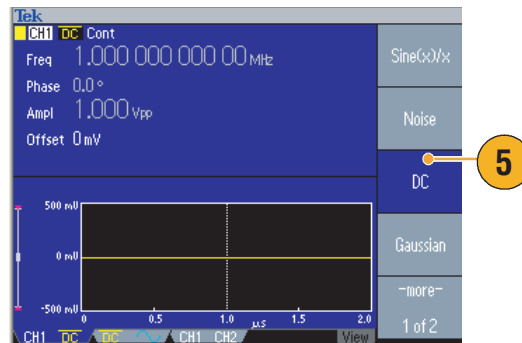

Quick Tip

- You cannot modulate or sweep noise or a DC waveform. See page 28.

Generate a Burst Waveform

The arbitrary/function generator can output a burst using standard waveforms such as sine, square, ramp, and pulse, or arbitrary waveforms. The instrument allows you to use the following two types of burst modes:

Triggered Burst Mode. A specified number (burst count) of waveform cycles are output when the instrument receives a trigger input from the internal trigger source, an external trigger source, a remote command, or the **Manual Trigger** button.

Gated Burst Mode. The instrument outputs a continuous waveform when an effective gate signal is applied externally, when the **Manual Trigger** button is depressed, when a remote command is applied, or during 50% of the selected internal trigger interval.

To Generate a Triggered Burst Waveform

The following example describes how to generate a double pulse using the burst mode.

1. Select Pulse as an output waveform and then push the front-panel **Burst** button.
2. Confirm that **1-Cycle**, **N-Cycles**, or **Inf-Cycles** is selected, which means triggered burst mode is enabled.
To generate double pulse, set the burst count (N-Cycles) to 2.

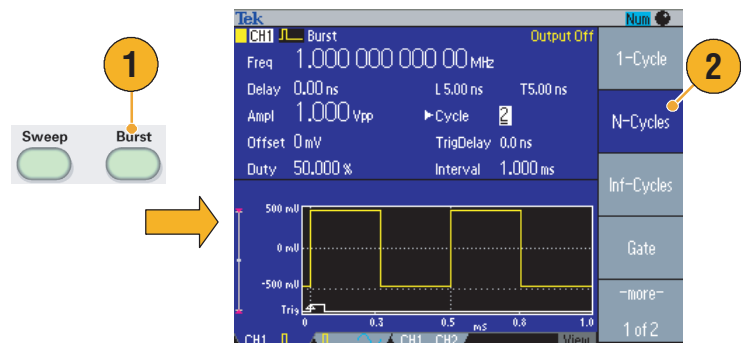

3. This is an example of double pulse.
4. This waveform is a trigger output signal.

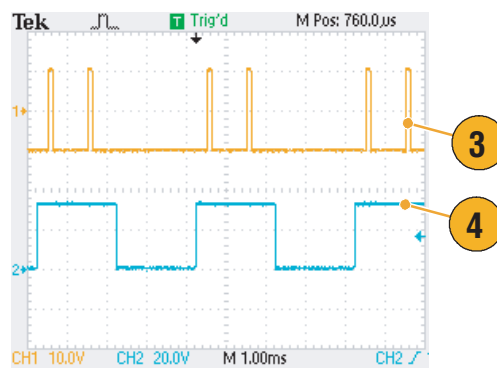

To Generate a Gated Burst Waveform

In the gated burst mode, the output is enabled or disabled based on the internal gate signal or an external signal applied to the front-panel **Trigger Input** connector. While the gate signal is true or the front-panel **Manual Trigger** button is pushed in, the instrument outputs a continuous waveform.

1. Push the front-panel **Burst** button to display the burst menu.
2. Select **Gate**.

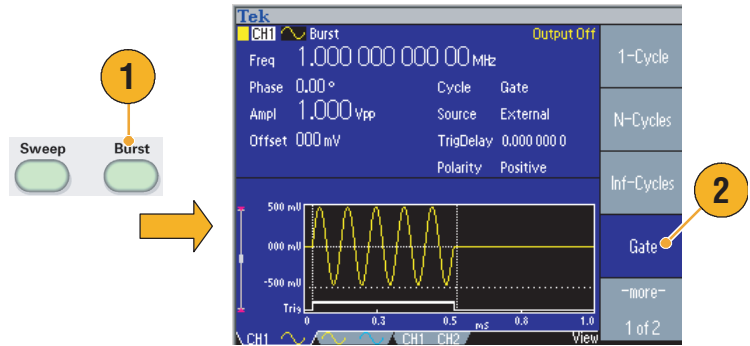

3. This is a sample oscilloscope screen. The top waveform is a trigger output signal.
4. This is a gated waveform sample.

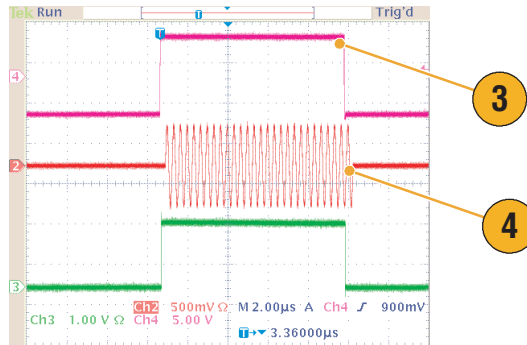

Quick Tips

- The instrument provides the following three trigger sources for Burst mode:
 - Internal or external trigger signal
 - Manual trigger
 - Remote command
- Once Gate is selected, burst count parameters are ignored.

Sweep a Waveform

The Sweep outputs a waveform with the output signal frequency varying linearly or logarithmically.

You can set the following parameters for Sweep:

- Start frequency
- Stop frequency
- Sweep time
- Return time
- Center frequency
- Frequency span
- Hold time

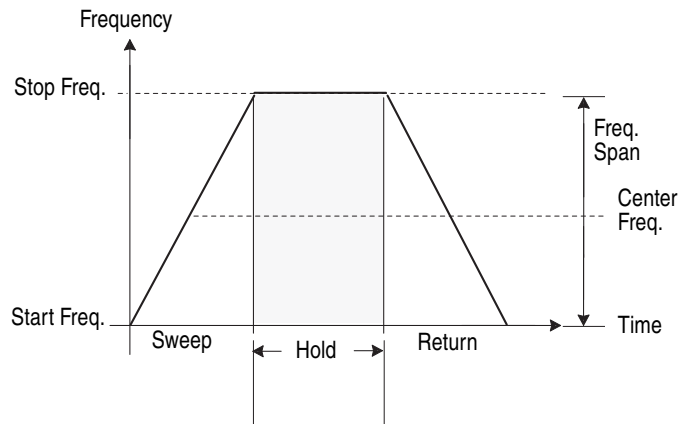

1. Select a waveform and then push the front-panel **Sweep** button.



2. You can specify the start frequency, stop frequency, sweep time and return time from the sweep menu.

Return Time represents the amount of time from Stop Frequency to Start Frequency.

Push the **-more-** button to display the second sweep menu.

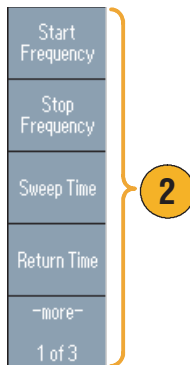

3. In this page, you can set the parameters for center frequency, frequency span, hold time and select the sweep type.

Hold time represents the amount of time that the frequency must remain stable after reaching the stop frequency.

Push the **-more-** button to display the second sweep menu.

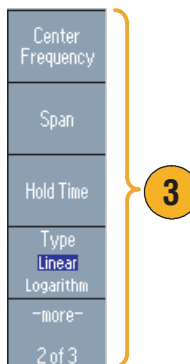

4. In this page, you can select the sweep mode (Repeat or Trigger) and trigger source.

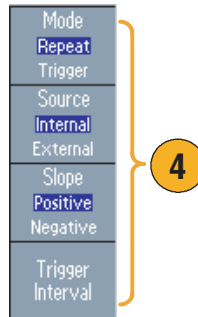

5. This is a sample oscilloscope screen. The top is a sample of a sweep waveform.

6. This is a trigger output signal.

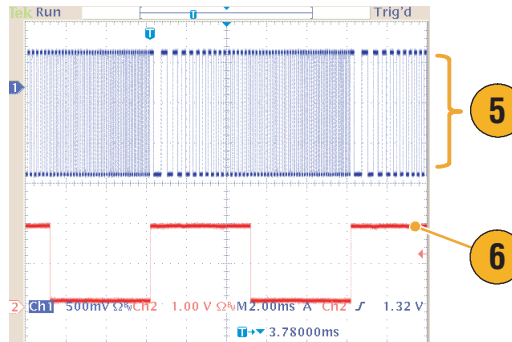

Quick Tips

- For frequency sweep, you can select a sine, square, ramp, or arbitrary waveform. Pulse, DC, and Noise waveforms cannot be selected.
- Once the sweep is selected, the frequency is swept from the sweep start to the sweep stop frequencies.
- If a start frequency is lower than a stop frequency, the instrument sweeps from the low frequency to the high frequency.
- If a start frequency is higher than a stop frequency, the instrument sweeps from the high frequency to the low frequency.
- If you want to return to the Sweep menu after selecting other menus, push the front-panel **Sweep** button again.

Modulate a Waveform

To Output an AM Waveform

1. Select a waveform and then push the front-panel **Modulation** button.

In this example, use sine waveform as an output waveform (carrier waveform).

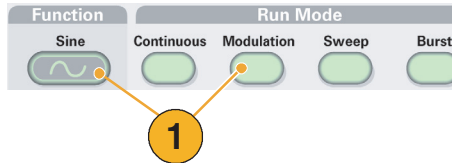

2. Push the top bezel button to display the modulation selection menu.

Select **AM** as the modulation type.

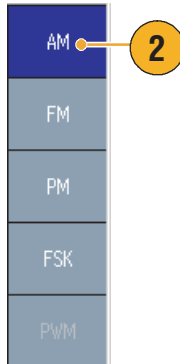

3. Select modulation source.

4. Set modulation frequency.

5. Select modulation shape.

6. Set modulation depth.

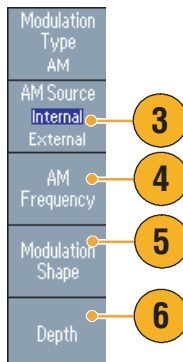

7. This is an example amplitude modulation waveform displayed on an oscilloscope screen.

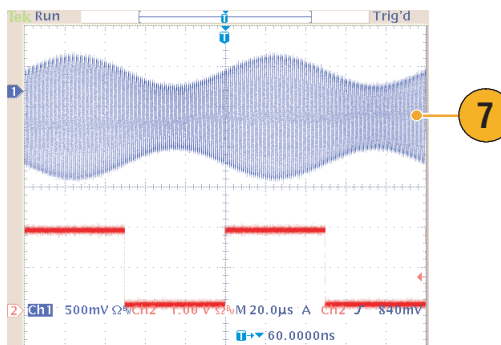

Quick Tips

- You can output frequency modulation or phase modulation waveforms in the same way.
- You cannot select Pulse, Noise, or DC as a carrier waveform.

- You can select an internal or external signal as an AM source. If you select an external source and set the modulation depth to 120%, the output will be at the maximum amplitude when a $\pm 1 V_{p-p}$ signal is applied to the rear panel EXT MODULATION INPUT connector.
- You can select a modulation shape from the internal memory or USB memory.
- The following equations show the output amplitude of AM, FM, and PM modulation (in this example, sine waveform is used for carrier waveform and modulation waveform):

$$\text{AM: Output}(V_{p-p}) = \frac{A}{2.2} \left(1 + \frac{M}{100} \sin(2\pi f_m t) \right) \sin(2\pi f_c t)$$

$$\text{FM: Output}(V_{p-p}) = A \sin(2\pi (f_c + D \sin(2\pi f_m t)) t)$$

$$\text{PM: Output}(V_{p-p}) = A \sin\left(2\pi f_c t + 2\pi \frac{P}{360} \sin(2\pi f_m t)\right)$$

Carrier amplitude	A [V _{p-p}]
Carrier frequency	f _c [Hz]
Modulation frequency	f _m [Hz]
Time	t [sec]
AM Modulation depth	M [%]
FM Deviation	D [Hz]
PM Deviation	P [degree]

- The following table shows relationship between modulation depth and maximum amplitude for AM modulation waveform (internal modulation source is selected):

Depth	Maximum amplitude
120%	A (V _{p-p})
100%	A (V _{p-p}) * 0.909
50%	A (V _{p-p}) * 0.682
0%	A (V _{p-p}) * 0.455

To Output an FSK Waveform

Frequency Shift Keying modulation is a modulation technique that shifts the output signal frequency between two frequencies: the carrier frequency and Hop frequency.

1. Follow the steps described on page 46 to display the modulation type selection submenu.

In this example, select **FSK** as the modulation type.

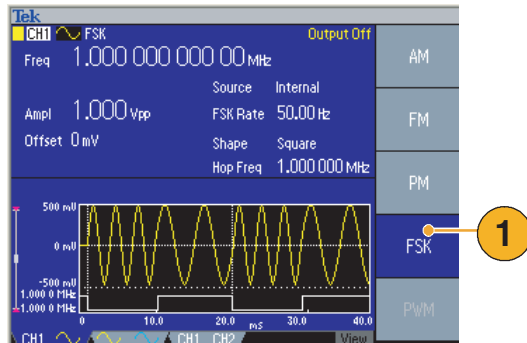

2. The FSK parameter setting screen is displayed.

Select **Internal** or **External** as FSK source.

3. If you select Internal, you can set the **FSK Rate**.

If you select **External**, the FSK Rate is ignored.

4. Set **Hop Frequency**.

Carrier waveform frequency shifts to the Hop frequency with the specified FSK rate, and then returns to the original frequency.

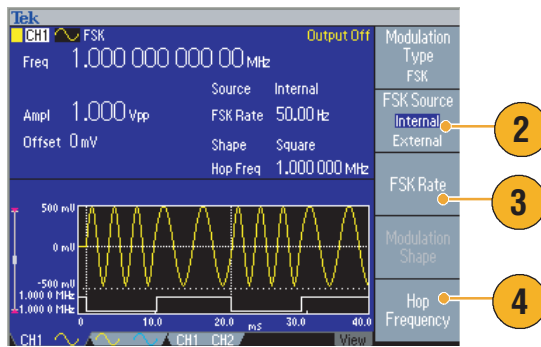

Quick Tip

- The AFG3000 series instruments generate a phase continuous FSK signal.

To Output a PWM Waveform

Follow these steps to output a PWM waveform.

1. Push the front-panel **Pulse** button, and then push the **Pulse Parameter Menu** bezel button to display the pulse parameter setting screen.

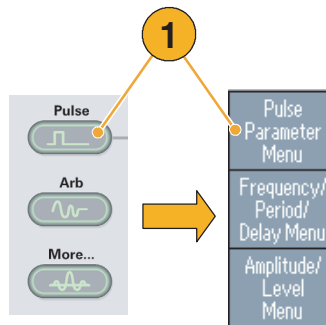

2. Push the front-panel **Modulation** button to display the PWM parameter setting screen.

Select the PWM source.

3. Set the PWM frequency.
4. Select the Modulation Shape.
5. Set the Deviation (pulse width deviation).

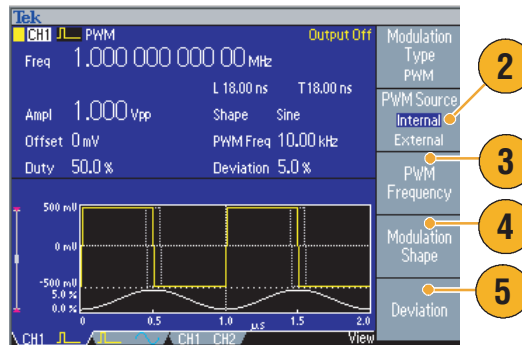

Quick Tip

- Refer to page 75 for an application example of pulse-width modulation.

Trigger Out

The Trigger Output signal of the arbitrary/function generator is linked to run mode and function selected in CH1, if your instrument is a dual-channel model.

1. Connect the front-panel **Trigger Output** connector and the external trigger input connector of the oscilloscopes. The Trigger Output connector provides the trigger signal for oscilloscopes.

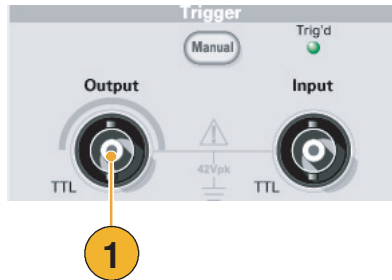

2. Continuous mode:
The trigger output is a square waveform and the rising edge at the start of each waveform period.

When an output frequency is higher than 4.9 MHz, some restrictions are applied. See the Quick Tips below.

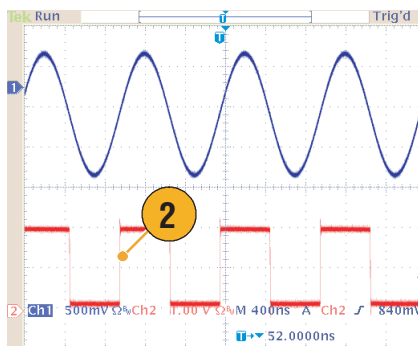

3. Sweep mode:
When the **Repeat** or **Trigger** sweep mode and internal trigger source are selected, the trigger output is a square waveform and the rising edge at the start of each sweep.

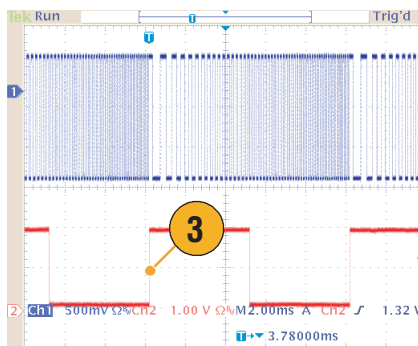

4. Modulation mode:
When internal modulation source is selected, the trigger output is a square waveform of the same frequency as the modulating signal.

When an external modulation source is selected, the trigger output is disabled.

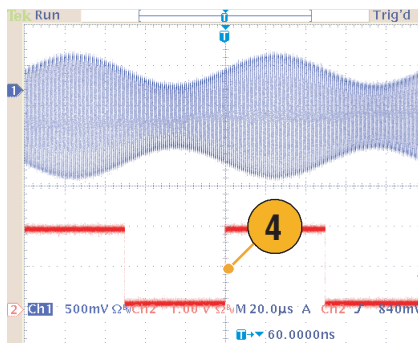

5. Burst Mode:

When internal trigger source is selected, the trigger output is a square waveform and the rising edge at the start of each burst period.

When an external trigger source is selected, the trigger output is high during the time the trigger input is high.

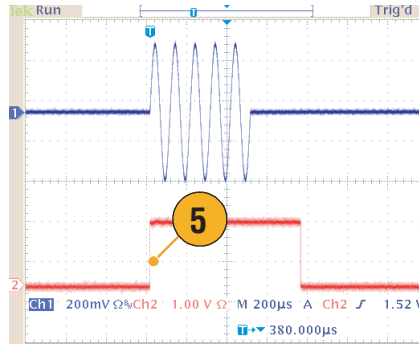

Quick Tips

- When a setting frequency of an output waveform is higher than 4.9 MHz, a divided frequency that is lower than 4.9 MHz is output from the Trigger Out. See the table below:

Set frequency of output waveform (MHz)	Trigger output frequency (MHz)
~ 4.900 000 000 00	Fs ¹
4.900 000 000 01 to 14.700 000 000 0	Fs/3
14.700 000 000 1 to 24.500 000 000 0	Fs/5
24.500 000 000 1 to 34.300 000 000 0	Fs/7
34.300 000 000 1 to 44.100 000 000 0	Fs/9
44.100 000 000 1 to 50.000 000 000 0	Fs/11
50.000 000 000 1 ~	No signal

1. Fs represents setting frequency of output waveform.

NOTE. The Trigger Out signal cannot be output when the instrument outputs a continuous signal higher than 50 MHz.

NOTE. When the instrument outputs a modulation waveform, Trigger Output signal cannot be output if you select External as the modulation source.

Adjusting Parameters of Two Channel Signals (dual-channel model only)

Phase

The AFG3000 series uses phase continuous method to change frequency. When you change a frequency of a channel, it will affect the phase relationship between the two channels.

For example, the instrument is generating a 5 MHz sine waveform for both CH1 and CH2 and the phase is adjusted between the two channels. If you change the CH2 frequency to 10 MHz and then return it to 5 MHz, the CH2 phase does not return to its initial condition. To adjust the phase relationship between the two channels, you need to stop signal generation and restart it. The instrument provides a function called "Align Phase" to adjust the phase relationship.

1. In this example, a 5 MHz continuous sine waveform is used. Confirm that both phases are set to 0 degrees.

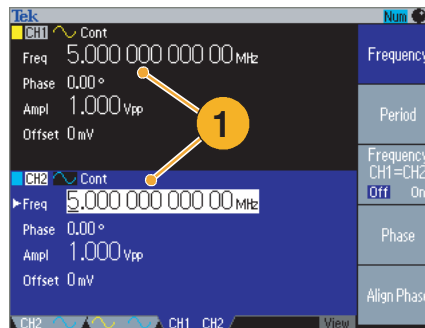

2. Change the CH1 frequency to 10 MHz, and then back to 5 MHz. In this state, the CH2 phase does not return to its initial condition.

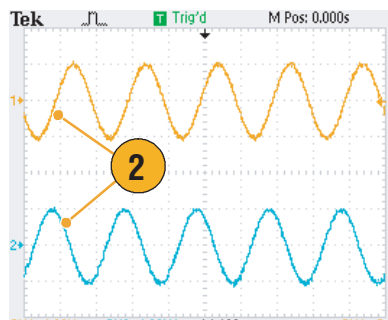

3. To align the phase of two channel signals, push the **Align Phase** bezel button.
4. When you push the **Align Phase** button, the instrument will stop the signal generation, adjust the phases of both channels, and automatically restart the signal generation.

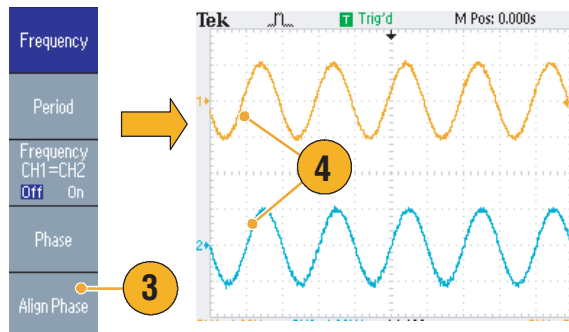

Amplitude

To set the CH1 amplitude and CH2 amplitude to the same level, follow these steps:

1. Push the front-panel **Amplitude/High** shortcut button.
2. Push the **-more-** bezel button.

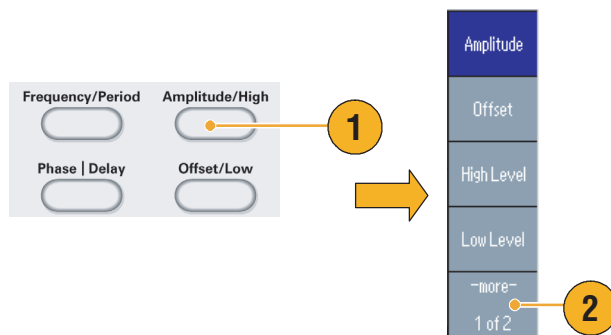

3. Page two of Amplitude/Level Menu is displayed.
You can set the CH1 and CH2 amplitude to the same level by selecting **On** in the second bezel menu from the top.

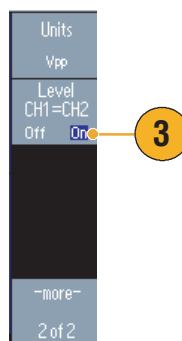

Frequency (Period)

To set the CH1 frequency and CH2 frequency to the same value, follow these steps:

1. Push the front-panel **Frequency/Period** shortcut button to display the Frequency/Period Parameter Menu.
2. You can set the CH1 and CH2 frequency to the same value by selecting **On** in the third bezel menu from the top.

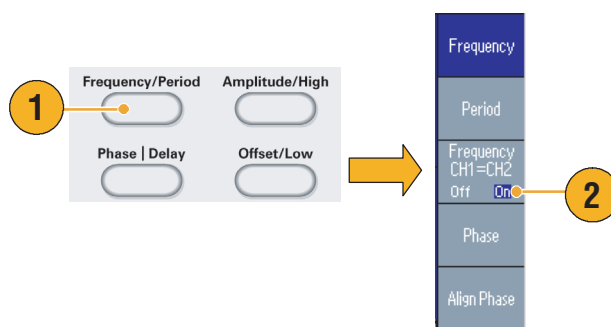

Set up Load Impedance

The output impedance of the AFG3000 series is 50 Ω. If you connect a load other than 50 Ω, the displayed Amplitude, Offset, and High/Low values are different from the output voltage. To make the displayed values same as output voltage, you need to set load impedance. To set the load impedance, use the Output menu.

1. Push the front-panel Top Menu  button, and then push the **Output Menu** bezel button. The Output Menu is displayed.
2. Push **Load Impedance** to display the Load Impedance submenu.

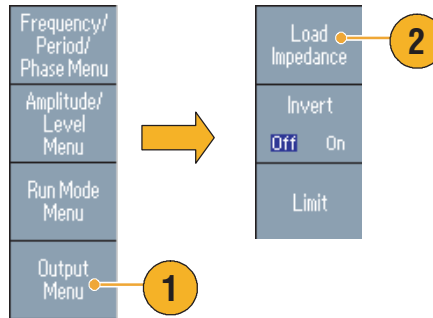

3. To adjust the load impedance, select **Load**.
4. You can set the load impedance to any value from 1 Ω to 10 kΩ.
5. When the load impedance is set to other than 50 Ω, the set value is displayed in the output status.

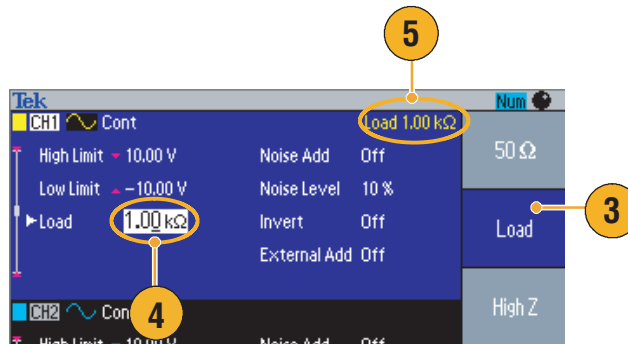

Quick Tips

- The load impedance is applied to the amplitude, offset, and high/low level settings.
- When **dBm** is specified for output amplitude units, the amplitude units setting is automatically changed to **V_{pp}** if you select high impedance.

Invert Waveform Polarity

To invert a waveform polarity, use the Output menu. The following example shows how to get a differential signal using the invert function of dual channel model:

1. Select the CH1 waveform.
2. Push the front-panel **Frequency/Period** button.
3. Push the **Frequency** bezel button to set the CH1 frequency.
4. Select the third bezel button from the top to set the two channel frequencies to the same value.

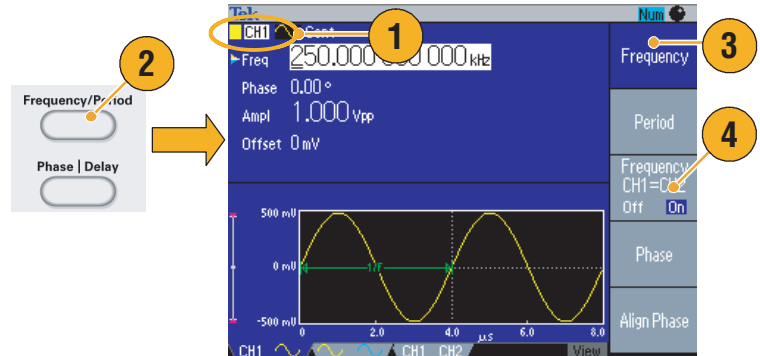

5. Push the front-panel **Channel Select** button to select CH2.
6. Push the **Output Menu > Invert** bezel buttons to invert the CH2 waveform.

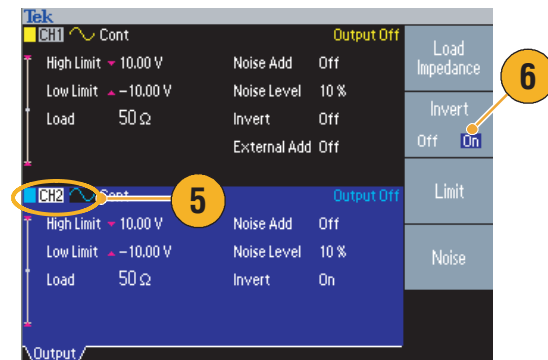

7. Push the front-panel CH1 Output **On** button to enable the output.
8. You can get a differential signal.

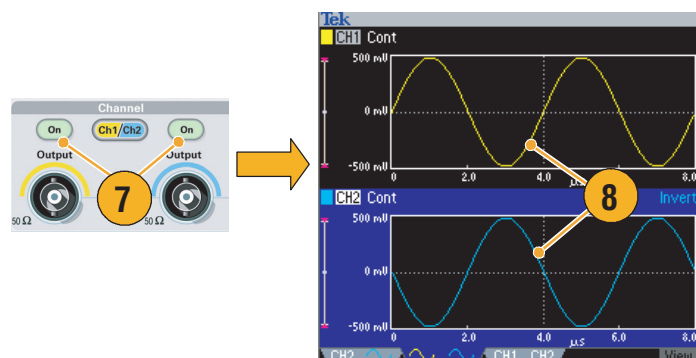

Add Noise

To add the internal noise signal to a waveform, use the Output menu.

1. Push the front-panel **Sine > Continuous** button to display the Sine waveform screen in this example.

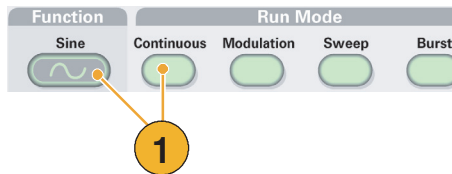

2. Follow the steps described on page 54 to display the Output Menu. To add noise to a sine waveform, push **Noise**.

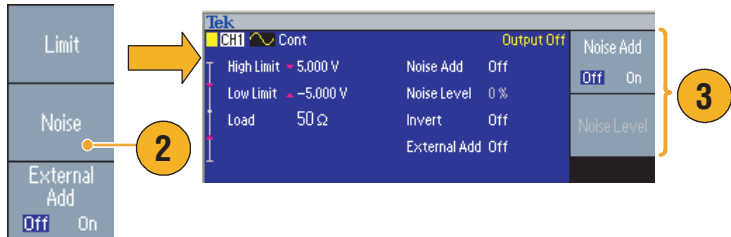

3. The Noise Add submenu is displayed. Push **Noise Add** to select **On**.

4. To adjust the noise level, push **Noise Level**. Use the general purpose knob or the numeric pad to enter the value.

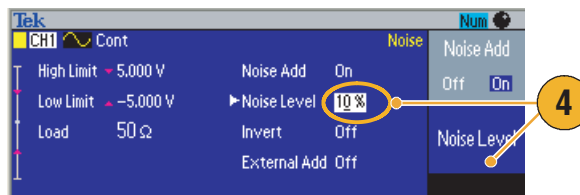

5. This is a waveform before adding noise.

6. This is a waveform after adding noise.

To avoid overflow by noise addition, the amplitude of the output signal is automatically halved.

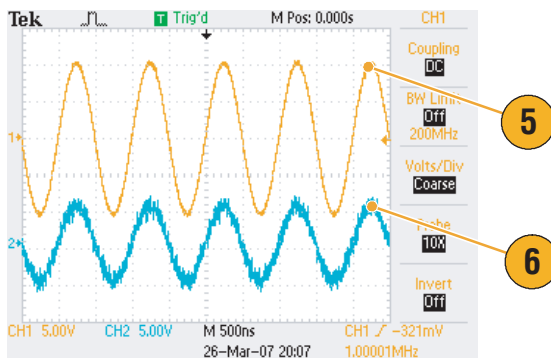

Quick Tips

- An internal noise generator (digital) is used to add noise.
- CH1 and CH2 noise signals are non-correlating.
- The Output Status (see page 24) is changed from **Output Off** to **Noise** when you push the front-panel **Channel Output** button to enable the output.

NOTE. When you set Noise Add to On, the amplitude of output signal is reduced to 50%.

Add Signal (AFG3100 and AFG3200 Series)

The AFG3101/AFG3102 and AFG3251/AFG3252 rear panel **ADD INPUT** connector allows you to add an external signal to the CH1 output signal.

1. Connect an external signal source to the rear panel **ADD INPUT** connector.

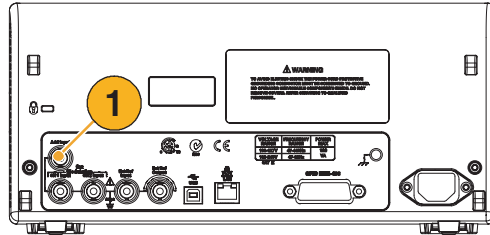

2. Push the front-panel Top Menu ^{Top Menu} button, and then push the **Output Menu** bezel button.
3. Push **External Add** to select **On**.

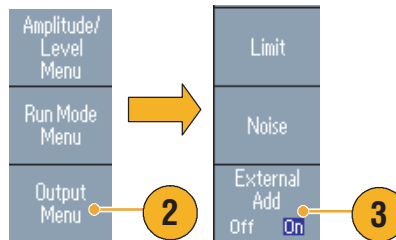

4. The following is an example of adding noise as an external signal. The upper waveform is an external signal.
5. The bottom waveform is a square wave before adding external signal.

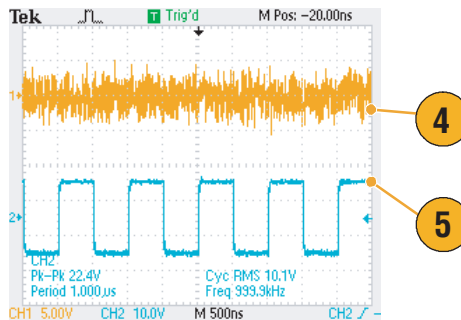

6. This is an example of square waveform after adding external signal (noise).



Quick Tip

- The Output Status (see page 24) is changed from **Output Off** to **Ext Add** when you push the front-panel **CH1 Output** button to enable the output.

External Reference Clock (AFG3100 and AFG3200 Series)

1. The external reference input (**EXT REF INPUT**) and the external reference output (**EXT REF OUTPUT**) connectors are provided on the AFG3000 series rear panel.

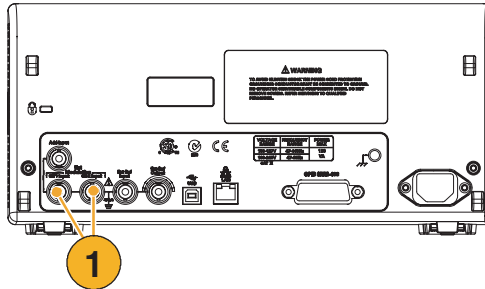

2. The instrument can use the internal or external signal as a reference signal.

To select a reference signal, push the front-panel **Utility** button and then push the **System** bezel button.

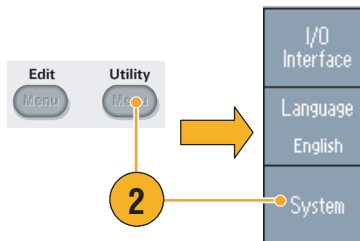

3. Push the **Clock Ref** bezel menu button to toggle between **Internal** and **External**.

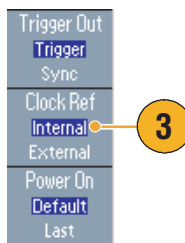

Quick Tips

- The external reference Input and Output connectors are used for synchronizing multiple AFG3000 series instruments. Refer to page 59 for synchronous operation.
- The arbitrary/function generator can use the internal source or an external source as a reference signal. When the *internal* reference is activated, a 10 MHz reference signal is output on the rear panel EXT REF OUT connector. This output signal synchronizes other devices to the arbitrary/function generator.
- When the *external* reference input is activated, the rear panel EXT REF INPUT connector is used as the input for an external reference signal. The arbitrary/function generator is synchronized by this external reference signal.
- The EXT REF OUTPUT connector is not provided with the AFG3021B and AFG3022B.

Synchronous Operation (AFG3100 and AFG3200 Series)

To synchronize multiple arbitrary/function generators, use the **Utility** menu. Some documentation may also refer to the synchronous operation as master-slave operation.

1. Use a BNC cable to connect the front-panel **Trigger Output** of one instrument (master) to the **Trigger Input** of another unit (slave).

The master unit sends a trigger signal to the slave unit.

2. Connect the rear panel **EXT REF OUT** (master) and **EXT REF IN** (slave) with another BNC cable.

The master clock and the slave clock are synchronized.

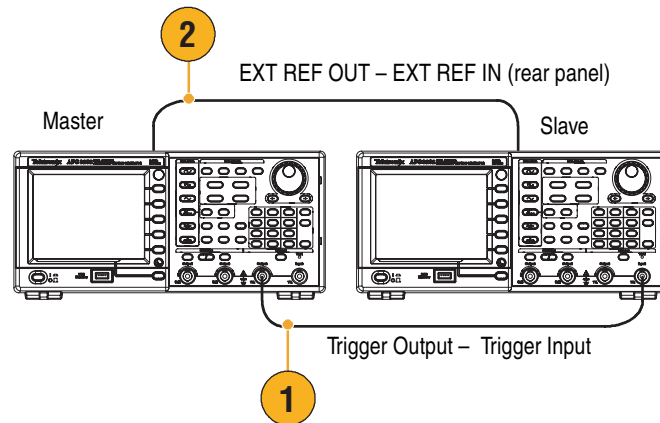

3. Push the front-panel **Utility** button of the master unit to display the System menu.

4. Sets the following:

- Trigger Out – Sync
- Clock Ref – Internal

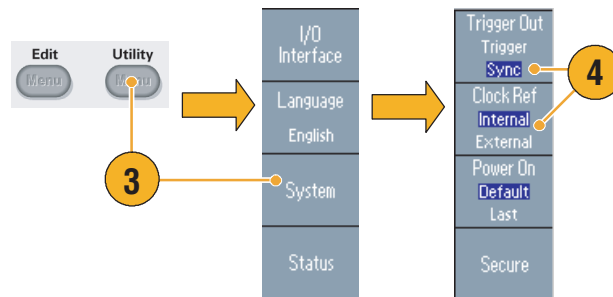

5. Set the slave instrument:

Display the System menu, and then push the **Clock Ref** bezel button to select **External**.

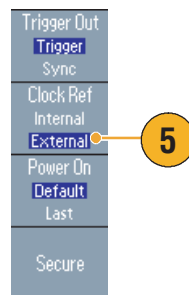

6. Select **Burst** as the Run Mode for both the master and the slave instrument.

To synchronize two instruments, you must stop running output signals once before triggering using the Burst mode.



7. Select the trigger source of the slave unit.

Push the **-more-** bezel button in the Burst mode to display the second page.

8. Push the **Source** bezel button to select **External**.

Confirm that **Internal** is selected in the master and **External** is selected in the slave for **Source**.

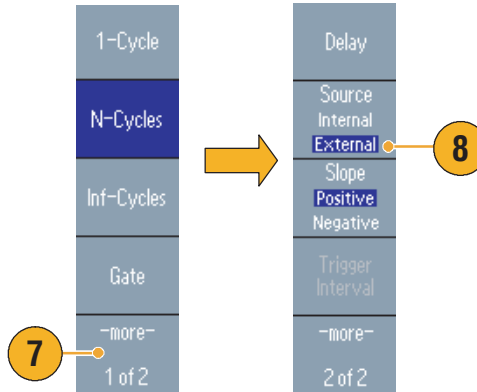

9. This screen shows signal outputs by master-slave operation. The top waveform is the signal of the master unit.

10. When one meter long cables are used, the slave signal(s) delays approximately 40 ns.

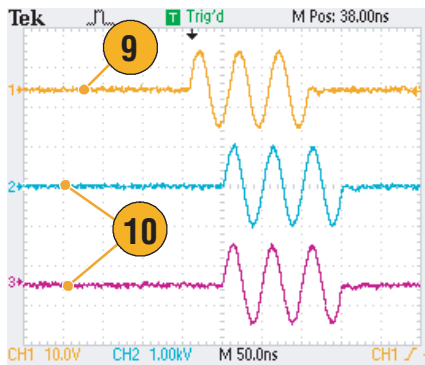

11. To make the delay between the master and slave 0 (zero), set **Delay** of the master unit.

12. The screen shows waveforms after setting the delay to the master unit. The top waveform is master and the two bottom waveforms are slaves.

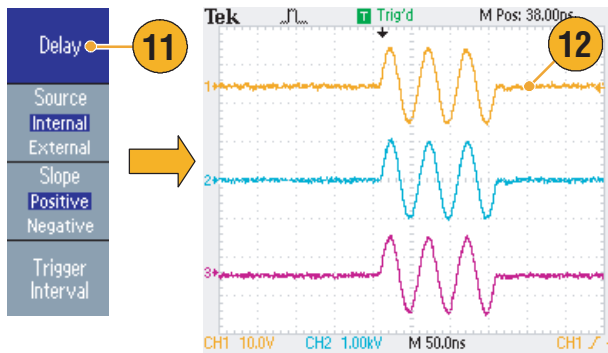

Quick Tip

- To output continuous waveforms by synchronous operation, select **External** as the trigger source for the master unit to stop signal generation. Select **Inf-Cycles** as the burst count for both master and slave units. Change the trigger source of the master unit to **Internal** to restart the signal generation.

USB Memory

A USB memory connector is provided with all the Tektronix AFG3000 Series Arbitrary/Function Generators to allow you to perform the following tasks:

- Save or recall user-defined waveforms to/from a USB memory
- Save or recall setups to/from files on a USB memory
- Update your arbitrary/function generator firmware



CAUTION. Do not remove USB memory while writing or reading data. It may cause data loss and the USB memory may be damaged.

When you attach a USB memory to the instrument, a caution message appears on the screen. Do not remove the USB memory until the message disappears.

If you remove the USB memory while this caution message is displayed, it may cause damage to the instrument.

For further information on saving/recalling user-defined waveforms, see page 36. For saving/recalling instrument setups, see page 64. For updating your arbitrary/function generator, see page 15.

Quick Tips

- Use a USB memory with cross section smaller than 20 mm x 12 mm to connect to the AFG3000 series front panel USB connector. To connect a larger USB memory, use an extension cord.
- The AFG3000 series instruments support a USB memory with a FAT12, FAT16, or FAT32 file system.

Utility Menu

Push the front-panel **Utility** button to display the Utility menu. The Utility menu provides access to utilities used by the instrument such as I/O interface, system related menus, diagnostics/calibration, and local language preferences.

1. Push the front-panel **Utility** button to display the Utility menu.
2. For I/O interface, see page 18.
3. For language selection, see page 11.
4. For System related menus, see step 6 and step 10.
5. Push the **Status** bezel button to display the instrument status.
6. Push the **System** bezel button to display the System submenu.
For Trigger Out, see page 50.
For synchronous operation, see page 59.
7. For Reference Clock, see page 58.
8. You can select the instrument power-on settings.
9. Executing the **Secure** function will erase all data except Mac Address, calibration data, and the instrument serial number.
10. Push the **-more-** button to display the second page. Push **Contrast** to adjust the screen contrast.
11. Push **Screen Saver** to toggle the screen saver **Off** and **On**.
12. Push **Click Tone** to toggle the click tone **Off** and **On**.
13. Push **Beeper** to toggle the beep sound **Off** and **On**.

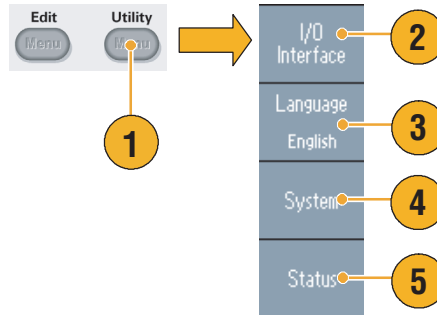

14. Push the front-panel  button to return to the previous menu. Push the **-more-** button to display the second page.

For Diagnostics and Calibration, see page 10.

15. For **Backup/Restore**, see step 17.

16. You can copy the waveform parameter of one channel to another channel.

17. Push the **Backup/Restore** bezel button to display the Backup/Restore sub-menu.

In this menu, you can back up a waveform data from internal memory to USB memory, or restore a waveform data from USB memory to internal memory.

18. Return to the Utility main menu. Push the **-more-** bezel button to display the third page. On this page, you can execute the instrument firmware update. See page 15.

19. For Security Menu, see page 65.

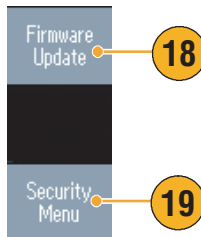
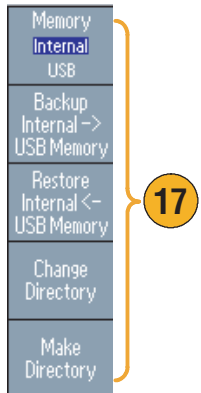
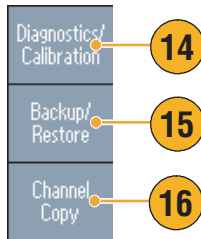

Save/Recall Instrument Setup

You can save setups of the arbitrary/function generator as files in the internal memory or in an external USB memory. You can recall the stored setups from a file in the internal memory or in a USB memory.

1. Push the front-panel **Save** button to display the Save Menu.

2. To specify a memory location, select **Internal** or **USB**. In this example, select **USB**.

Use the general purpose knob to scroll files. Push **Save** to save a setting.

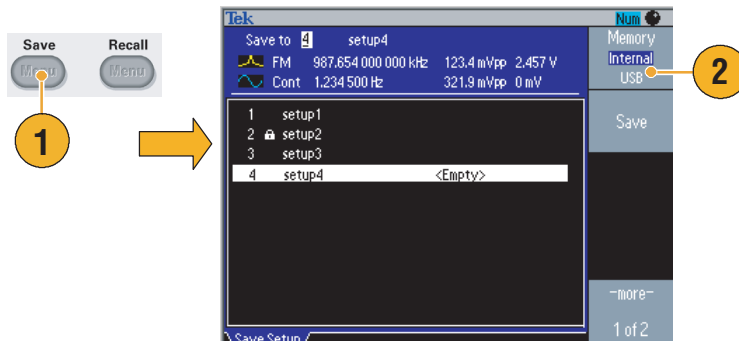

3. You can save a setup as a new file if you specify **USB**. Push **Save As**.

4. You can enter a file name in this screen. Use the general purpose knob to select a character. Push the **Enter Character** bezel button or the front-panel **Enter** key to enter the character.

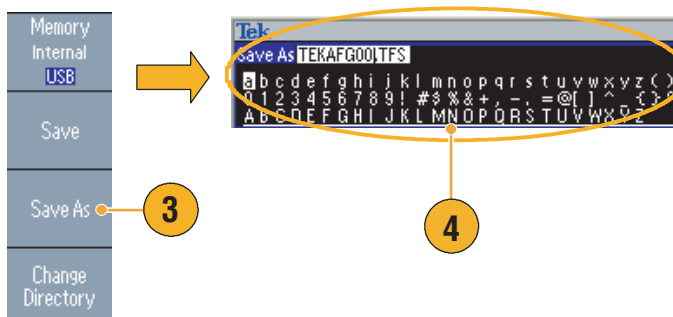

5. To recall a setup, push the front-panel **Recall** button.

6. Select a memory location (**Internal** or **USB**), and then push the **Recall** bezel button.

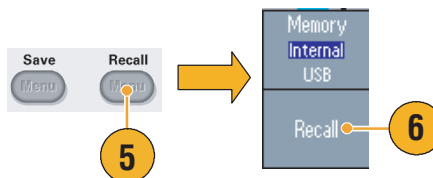

Quick Tips

- You can lock a setup file to avoid accidental overwrite. When a memory location is locked, a lock key icon will appear on the screen. To lock or unlock a setup file, push the **Lock/Unlock** bezel button.
- To erase a file, push the **Erase** bezel button.
- Output state is **Off** by default after reading a setup file.
- If you save a setup to a USB memory, a file with the extension TFS is saved.

Using the Security Menu

Use the Security menu to limit access to the following menus:

- Firmware update
- Service menu (Refer to the service manual for information about the service menu.)

Access Protection

The access protection is set to Off by default. To turn the access protection on, do the following steps:

1. Push the front-panel **Utility** button to display the Utility menu, and then push the **-more-** bezel button twice.
2. Select **Security Menu**.

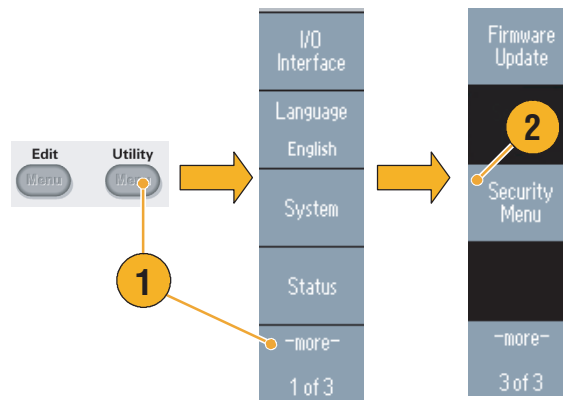

3. Select **Access Protection** to display the password input page.
4. Enter your password. Use the general purpose knob to select the characters and push the **Enter Character** bezel button after each selection.

As you enter the characters of your password, they are displayed as a series of asterisks (*****) on the password input page.

If no specific password has been previously defined, use the default password DEFAULT.

5. Select **OK** to turn the access protection on.

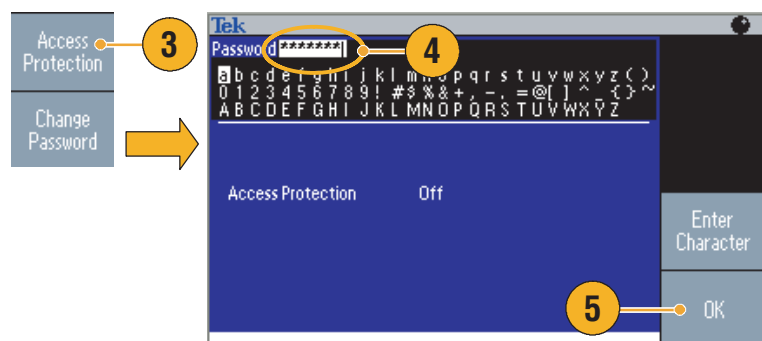

NOTE. When Access Protection is on, the Change Password bezel button is disabled.

Changing the Password

Before the password is changed for the first time, the default password is DEFAULT. To change the password, do the following steps:

1. Select **Security Menu** from the Utility menu.
2. If the Access Protection is set to On, turn it off using the **Access Protection** menu. Otherwise, skip to step 3.

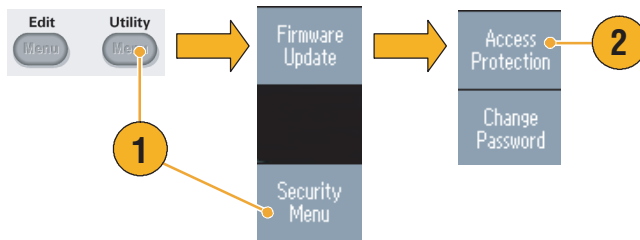

3. Select **Change Password** to display the password input page.
4. Enter your current password.

Use the general purpose knob to select the characters and push the **Enter Character** bezel button after each selection. Then select **OK** to display the New Password input page.



5. Enter a new password.

As you enter the characters of your new password, they are displayed on the screen. Check carefully to ensure you are entering the desired characters.
6. Select **OK** to activate the new password.

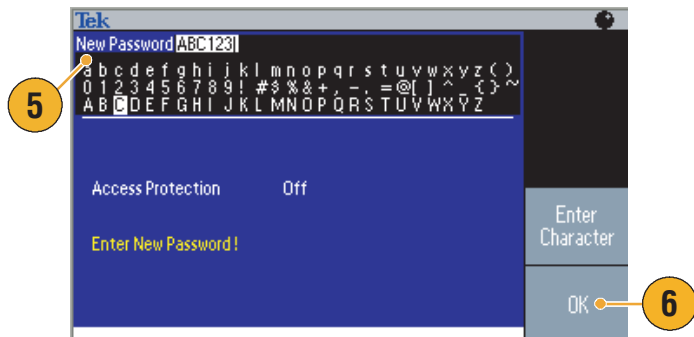

Note. A password must have at least four characters, and not more than 12 characters.

Quick Tip

- Use the front-panel general purpose knob to select a character when you enter a password, and then push the **Enter Character** bezel button. You can also use the front-panel numeric keypad and the **Enter** button.

NOTE. To activate or deactivate the access protection, you must enter the password you set. If you forget the password, you must return the instrument to Tektronix to reset the password.

ArbExpress

ArbExpress is a Windows-based software for creating and editing waveforms for Tektronix AWG and AFG instruments. With ArbExpress you can quickly and conveniently create the desired waveforms and send them to AFG3000 Series Arbitrary/Function Generators.

The following table and list describe the system requirements and general features.

System Requirements	
OS Supported	Windows XP Professional or Windows 2000 or Windows 98/Me or Windows NT
Minimum PC Requirements	Pentium III 800 MHz and higher 256 MB RAM 300 MB free hard disk Microsoft Internet Explorer 5.01 and higher .NET Framework 1.1 Redistributable 800 x 600 Display resolution
TekVISA	Version 2.03, build 97 or above

- Create waveforms from standard waveform templates
- Modify and transfer waveforms to perform DUT level tests
- Directly import waveforms from Tektronix oscilloscopes
- Send waveforms to AWG/AFG instruments directly from ArbExpress or MATLAB
- Math operations on waveforms

NOTE. You can use ArbExpress to transfer waveform data to the AFG3000 series instrument. When you transfer waveform data (.tfile), any part of the waveform outside of allowed limits in the AFG3000 series will be automatically converted to be within the allowed range.

The following pages contain the screen interface and basic operating procedures for using ArbExpress. For more information on ArbExpress, refer to the ArbExpress online help.

Screen Interface

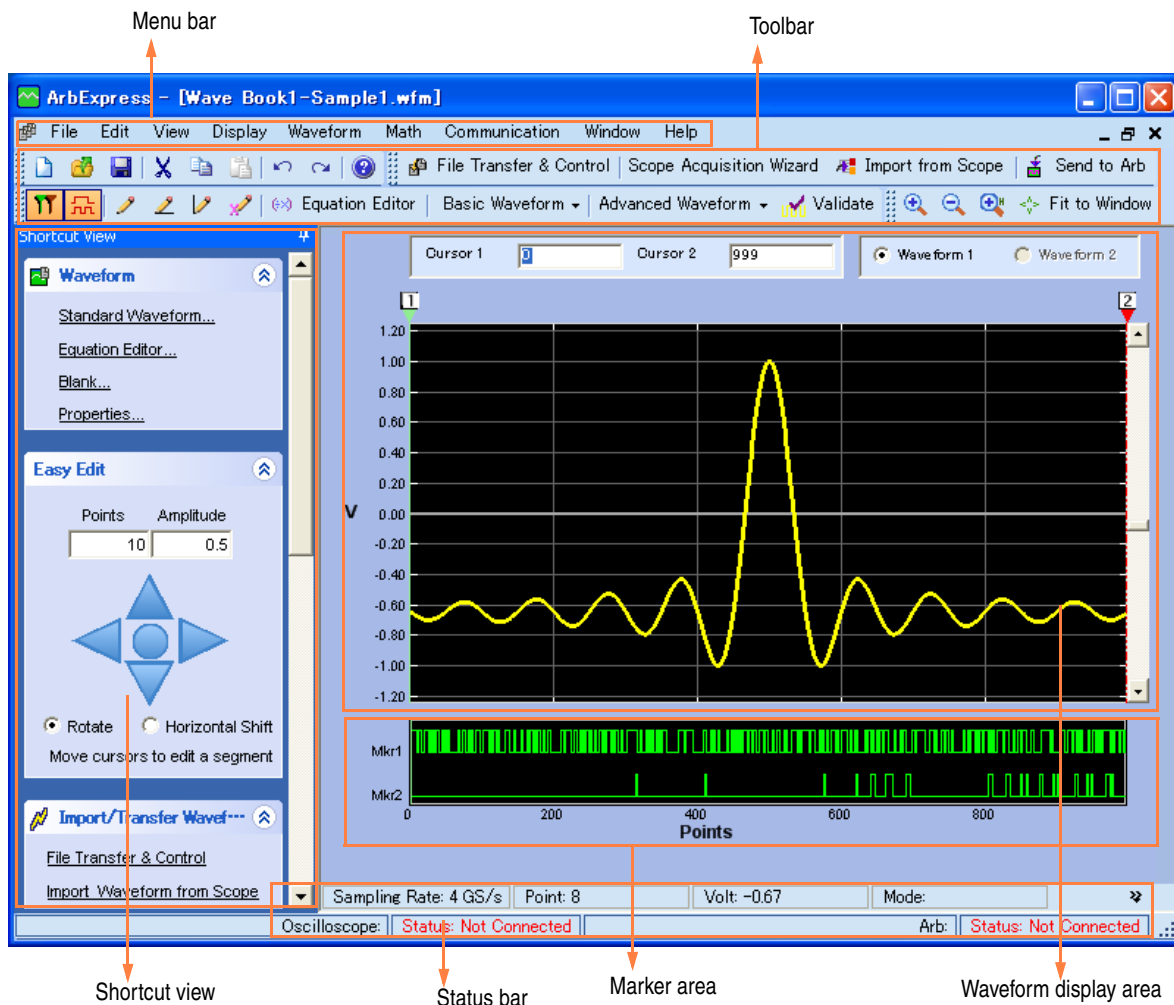

Menu bar. The menu bar provides access to the application functions. When you select a menu item, the application displays the associated dialog box or the menu selection causes an immediate action.

Toolbar. The toolbar buttons provide instant access to most features without having to navigate through several menus.

Shortcut view. The Shortcut view occupies the left part of the display. Use the Shortcut view to quickly access various functions provided by the application. Refer to the ArbExpress online help for more information.

Status bar. The status bar, located below the waveform and marker display, shows information about the application and the waveform.

Waveform display area. When you create or open a waveform, it will be displayed in this area.

Marker area. Marker patterns appear in this area. You can toggle the display of markers by selecting Display > Marker from the menu bar.

Basic Operations

The following steps explain basic waveform creation and other useful functions that are available with ArbExpress.

1. To create a new waveform, use the File menu.
2. Blank sheet opens a blank sheet in the window with 1024 points waveform length. You can change the number of points using **Properties...** from the Waveform menu.

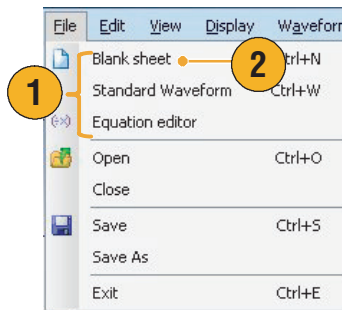

3. Use the Standard Waveform dialog box to create any of the standard waveforms that are available. Use **Settings** to select a desired waveform and instrument type.
4. Use **Vertical** to set the waveform vertical parameters.
5. Use **Horizontal** to set the waveform horizontal parameters.
6. Click **Preview** to view the waveform.

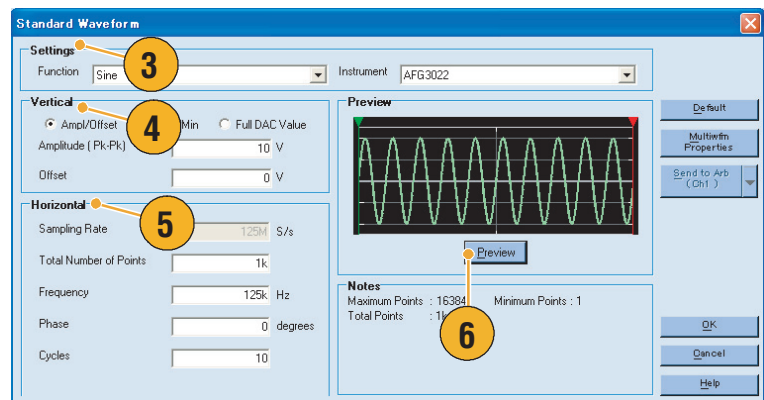

7. You can also use the Equation Editor to create a waveform. The application provides a set of sample equations that you can directly use or modify.
8. Use **Command List** to select the commands, functions, units, and operations.
9. Use **Preview** to view the waveform after the equation is compiled.

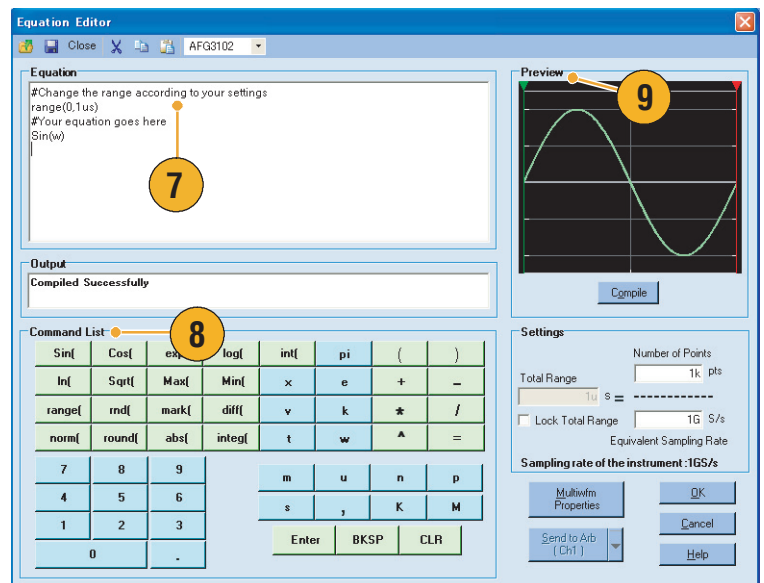

10. You can also use a waveform math tool.

From the Math menu, select **Waveform Math...** to display the Waveform Math dialog box.

11. Select a math source from Waveform Library. Select Noise in this example.

12. Calculation results are displayed in the Resultant Waveform pane. This is an example of adding noise to a square wave.

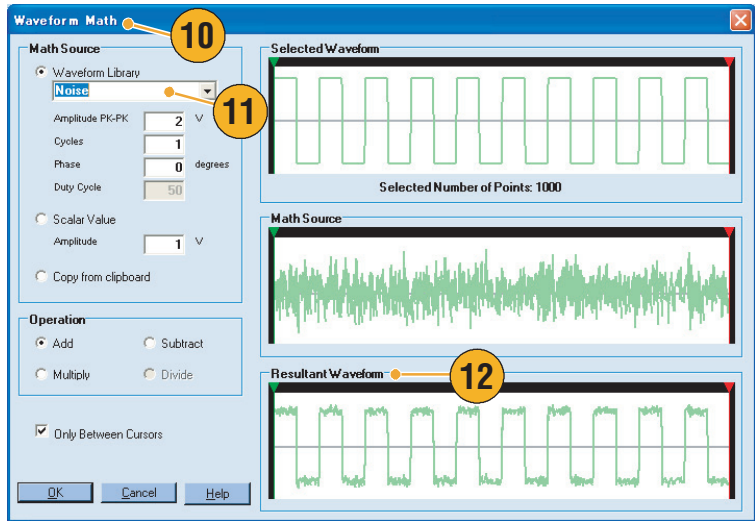

13. You can remotely control Tektronix AWG/AFG instruments using ArbExpress.

From the Communication menu, select **AWG/AFG File Transfer & Control...** to display the dialog box.

14. Connected instruments are listed on the **Arb List**.

15. The Instrument Control pane appears only when an instrument is connected, otherwise it is hidden.

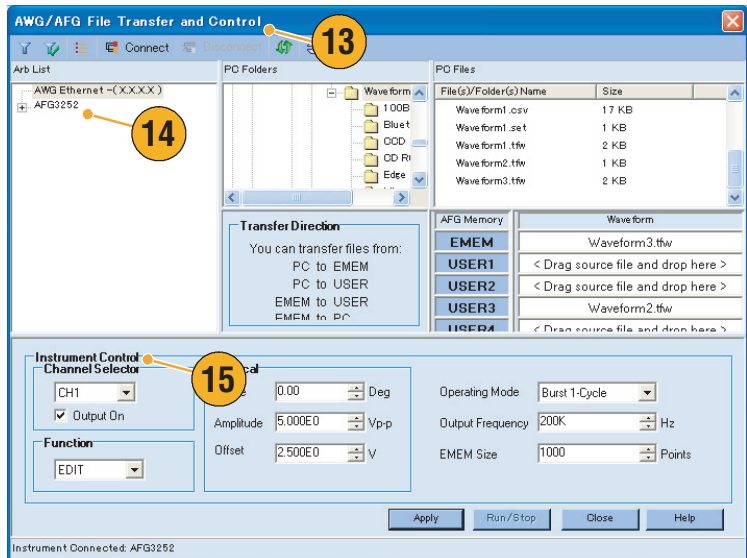

Using CSV Format Waveform Data with AFG3000 Series

ArbExpress allows you to convert a CSV (Comma Separated Value) format file, which is created by Microsoft Excel, to waveform data that is compatible with the AFG3000 series.

1. Create a CSV file to use with ArbExpress.
2. Enter point or time to this column.
3. Enter data to this column.

When you open a CSV file, a dialog box may appear to confirm the CSV file format.

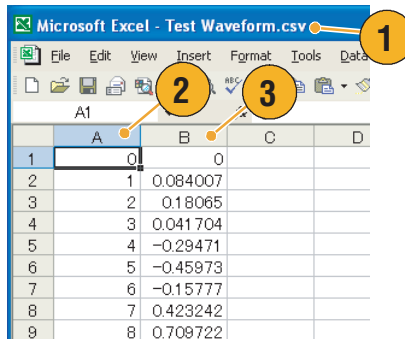

4. This is an example of ArbExpress waveform display area after recalling CSV data.

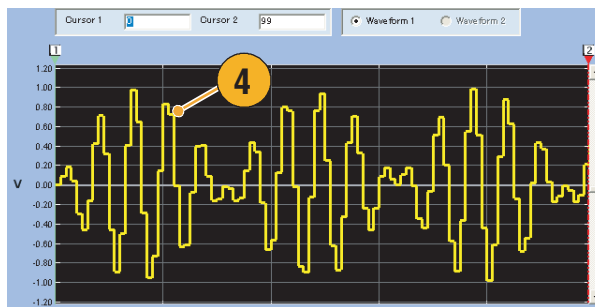

5. Save the waveform as the .tfw format.
Copy the waveform data to a USB memory and load the waveform in the AFG3000 series.

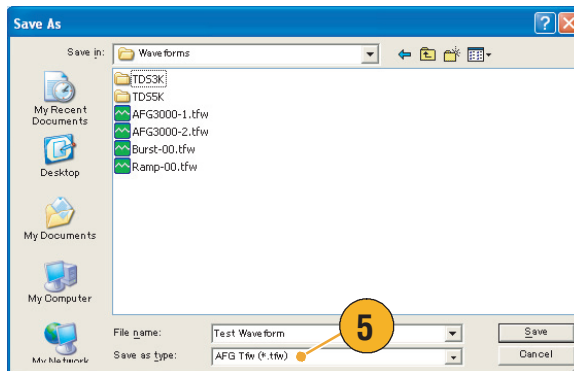

6. The AFG3000 series outputs recalled waveform data. This is an example of the oscilloscope screen.

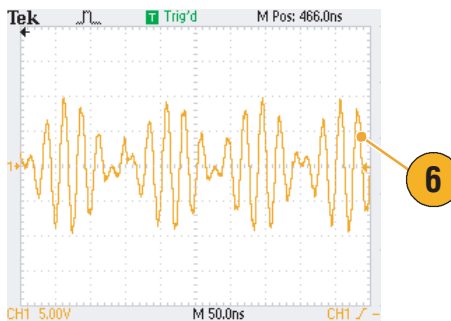

Application Examples

This section contains a series of application examples. These simplified examples highlight the features of the arbitrary/function generator and give you ideas for using it to solve your own test problems.

Lissajous Patterns

Use the AFG3000 series dual-channel model to create a Lissajous pattern and observe the waveforms with an oscilloscope.

1. Connect the CH1 and CH2 Outputs of the dual-channel arbitrary/function generator and the CH1 and CH2 Inputs of an oscilloscope with BNC cables. Set the waveform parameters as follows:
 - Sine (Continuos)
 - Amplitude: 1 V
 - CH1 Frequency: 400 kHz
 - CH2 Frequency: 500 kHz
2. Set the oscilloscope display format to XY. Adjust the amplitude so that the waveform is shown in the graticule. A Lissajous pattern is displayed.

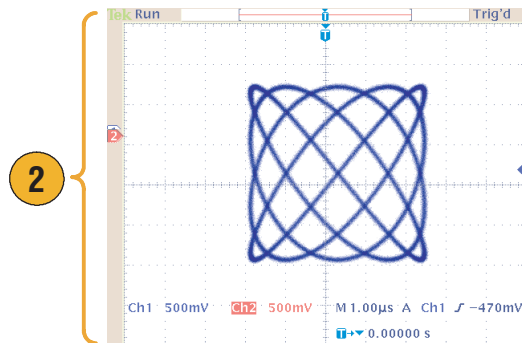
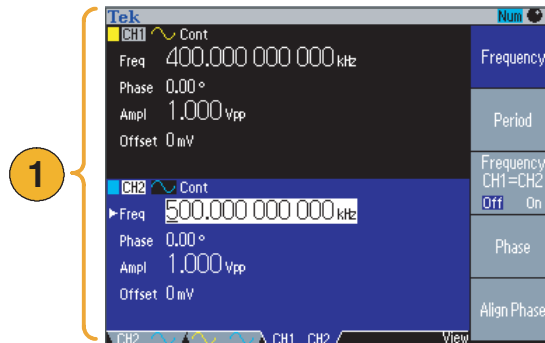

3. Use the general purpose knob on the arbitrary/function generator to change the phase of CH1 or CH2. Observe that the Lissajous pattern changes shape.

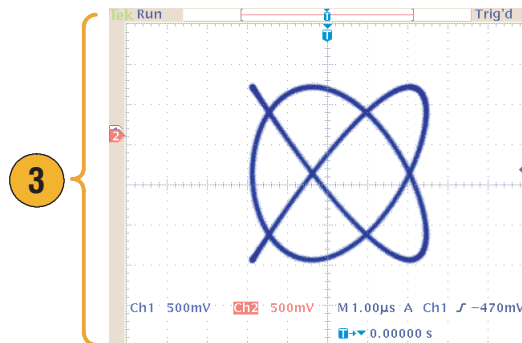

Measurement of Filter Characteristics

Use the arbitrary/function generator sweep function to observe the frequency characteristics of the 50 Ω filter.

1. Connect the CH1 output of the arbitrary/function generator and an oscilloscope CH1 input with a BNC cable.
2. Connect the Trigger Output of the arbitrary/function generator and the external trigger input connector of an oscilloscope.

Set the oscilloscope input impedance to 50 Ω .

3. Select **Sweep** from Run Mode of the arbitrary/function generator and set the start frequency, stop frequency, and sweep time so that the waveform is shown in the graticule.

You can measure the frequency characteristics of the filter by sweep time and the oscilloscope time base.

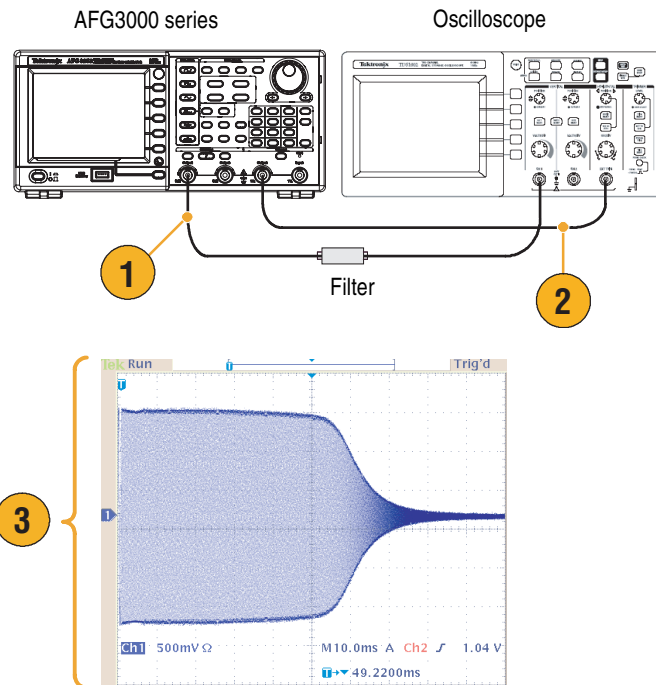

Motor Speed Control by Pulse-Width Modulation

Pulse-width modulation is used for controlling the speed of a DC motor or the luminance of an LED (Light Emitting Diode). Use the arbitrary/function generator PWM function to control the DC motor speed.

1. Connect the arbitrary/function generator output and a DUT using a BNC-to-alligator clip adapter.

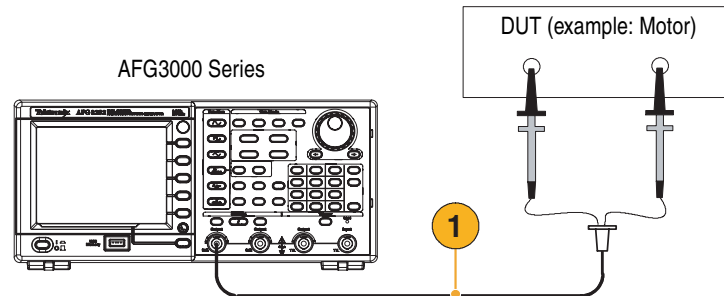

2. Select **Pulse** as an output waveform and then select **PWM** as a modulation type.

Set the frequency to approximately 100 kHz.

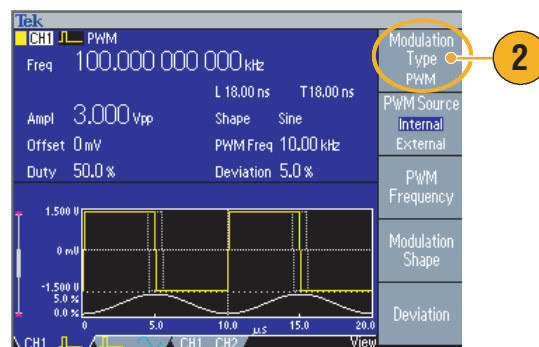

3. Connect the output to an oscilloscope. Confirm that a pulse-width modulation waveform is displayed on the oscilloscope screen.

Select **Pulse Duty** and change the duty rate. Observe that the motor speed changes if you change the duty rate.

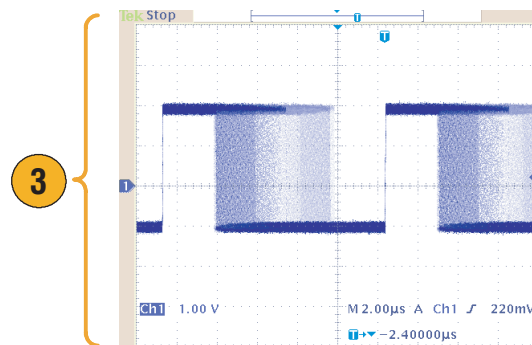

Carrier Null (Frequency Modulation)

Use the arbitrary/function generator and spectrum analyzer to observe a carrier waveform of frequency modulation.

1. Select **Sine** as an output waveform and then select **FM** as the modulation type.
2. Set the waveform parameters as follows:
 - Carrier frequency: 1 MHz
 - Modulation frequency: 2 kHz

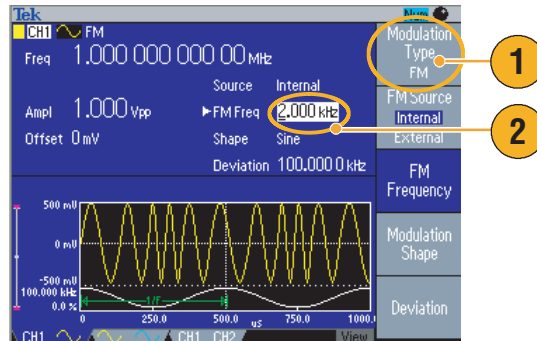

3. Change **Deviation**.

Set the deviation to 4.8096 kHz. It makes the carrier waveform null. Confirm that the carrier null can be observed on the spectrum analyzer.

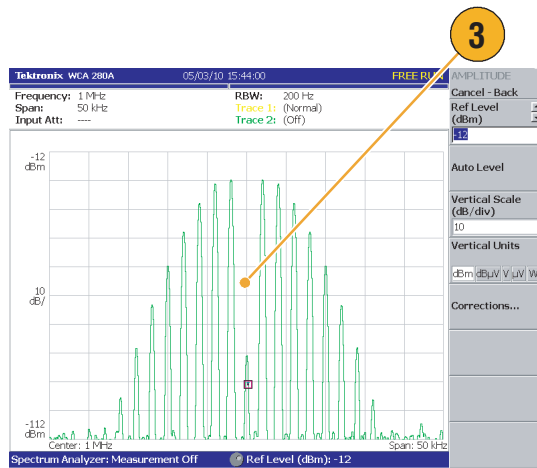

Specifications

This section contains the specifications for the AFG3000 Series Arbitrary/Function Generators. All specifications are guaranteed unless noted as “typical”. Typical specifications are provided for your convenience but are not guaranteed. Specifications that are marked with ✓ symbol are checked in Performance Verification section of the service manual, an optional accessory.

All specifications apply to the arbitrary/function generator unless noted otherwise. These specifications are valid under three conditions:

- The arbitrary/function generator must have been calibrated/adjusted at an ambient temperature between +20 °C and +30 °C.
- The arbitrary/function generator must have been operating continuously for 20 minutes within the specified operating temperature range.
- The instrument must be in an environment with temperature, altitude, and humidity with the operating limits described in these specifications.

Electrical

Operating Mode

Run Mode	Continuous, Modulation, Sweep, and Burst
Burst Count	1 to 1,000,000 cycles or Infinite
Internal Trigger Rate	1.000 ms to 500.0 s

Waveforms

Standard	Sine, Square, Pulse, Ramp, More (Sin(x)/x, Noise, DC, Gaussian, Lorentz, Exponential Rise, Exponential Decay, and Haversine)				
Arbitrary Waveform	AFG3021B/AFG3022B	AFG3101/AFG3102		AFG3251/AFG3252	
Waveform Length	2 to 131,072	2 to 16,384	>16,384 to 131,072	2 to 16,384	>16,384 to 131,072
Sampling Rate	250 MS/s	1 GS/s	250 MS/s	2 GS/s	250 MS/s
Resolution	14 bits				
Non-volatile Waveform Memory	4				
Frequency	AFG3021B/AFG3022B	AFG3101/AFG3102		AFG3251/AFG3252	
Sine ¹	1 μHz to 25 MHz	1 μHz to 100 MHz		1 μHz to 240 MHz	
Square	1 μHz to 12.5 MHz	1 μHz to 50 MHz		1 μHz to 120 MHz	
Pulse	1 mHz to 12.5 MHz	1 mHz to 50 MHz		1 mHz to 120 MHz	
Ramp, Sin(x)/x, Gaussian, Lorentz, Exponential Rise, Exponential Decay, Haversine	1 μHz to 250 kHz	1 μHz to 1 MHz		1 μHz to 2.4 MHz	
Arbitrary	1 mHz to 12.5 MHz	1 mHz to 50 MHz		1 mHz to 120 MHz	

Waveforms (cont.)

Resolution	1 μ Hz or 12 digits		
✓Accuracy (Stability)	± 1 ppm, 0 °C to 50 °C (except Arb) ± 1 ppm ± 1 μ Hz, 0 °C to 50 °C (Arb)		
Accuracy (Aging)	± 1 ppm/year		
Phase (except DC, Noise, Pulse)			
Range ²	-180.00° to +180.00°		
Lead Delay (Pulse)			
Range	0 ps to Period – [Pulse Width + 0.8 * (Leading Edge Time + Trailing Edge Time)]		
Resolution	10 ps or 8 digits		
Amplitude (50 Ω)	AFG3021B/AFG3022B	AFG3101/AFG3102	AFG3251/AFG3252
Range ^{3, 4}	10 mV _{p-p} to 10 V _{p-p}	20 mV _{p-p} to 10 V _{p-p}	50 mV _{p-p} to 5 V _{p-p}
✓Accuracy	$\pm(1\%$ of setting + 1 mV) (1 kHz sine waveform, 0 V offset, >10 mV _{p-p} amplitude)		
Resolution	0.1 mV _{p-p} , 0.1 mV _{rms} , 1 mV, 0.1 dBm or 4 digits		
Units ⁵	V _{p-p} , V _{rms} , dBm, and Volt (High Level and Low Level)		
Output Impedance	50 Ω		
Isolation	42 V _{pk} maximum to earth		
DC Offset (50 Ω)	AFG3021B/AFG3022B	AFG3101/AFG3102	AFG3251/AFG3252
Range ⁶	± 5 V _{pk} ac + dc into 50 Ω		± 2.5 V _{pk} ac + dc into 50 Ω
✓Accuracy ⁷	$\pm(1\%$ of setting + 5 mV + 0.5% of amplitude (V _{p-p}))		
Resolution	1 mV		
Internal Noise Add			
Range	0.0% to 50% of amplitude setting (V _{p-p}) of signal waveform		
Resolution	1%		

1. Triggered/Gated Burst Mode:
AFG3021B/AFG3022B, 1 μ Hz to 12.5 MHz
AFG3101/AFG3102, 1 μ Hz to 50 MHz
AFG3251/AFG3252, 1 μ Hz to 120 MHz
2. Resolution: 0.01° (sine), 0.1° (other standard waveforms)
3. AFG3021B/AFG3022B: 20 mV_{p-p} to 20 V_{p-p} into open circuit load
AFG3101/AFG3102: 40 mV_{p-p} to 20 V_{p-p} into open circuit load
AFG3251/AFG3252: 100 mV_{p-p} to 10 V_{p-p} into open circuit load
4. AFG3251/AFG3252 (frequency range: >200 MHz to 240 MHz): 50 mV_{p-p} to 4 V_{p-p} into 50 Ω , 100 mV_{p-p} to 8 V_{p-p} into open circuit load
5. dBm is used only for sine waveform.
6. AFG3021B/AFG3022B and AFG3101/AFG3102: ± 10 V_{pk} ac + dc into open circuit load
AFG3251/AFG3252: ± 5 V_{pk} ac + dc into open circuit load
7. AFG3021B/AFG3022B and AFG3101/AFG3102: Add 0.5 mV per °C for operation outside the range of 20 °C to 30 °C.
AFG3251/AFG3252: Add 2.0 mV per °C for operation outside the range of 20 °C to 30 °C.

Output Characteristics

Sine Wave	AFG3021B/AFG3022B	AFG3101/AFG3102	AFG3251/AFG3252
✓Flatness (at 1.0 V _{p-p} amplitude (+4 dBm), relative to 100 kHz)	<5 MHz: ±0.15 dB ≥5 MHz to 20 MHz: ±0.3 dB ≥20 MHz to 25 MHz: ±0.5 dB	<5 MHz: ±0.15 dB ≥5 MHz to 25 MHz: ±0.3 dB ≥25 MHz to 100 MHz: ±0.5 dB	<5 MHz: ±0.15 dB ≥5 MHz to 25 MHz: ±0.3 dB ≥25 MHz to 100 MHz: ±0.5 dB ≥100 MHz to 200 MHz: ±1.0 dB ≥200 MHz to 240 MHz: ±2.0 dB
✓Harmonic Distortion (at 1.0 V _{p-p} amplitude)	10 Hz to 20 kHz: <-70 dBc ≥20 kHz to 1 MHz: <-60 dBc ≥1 MHz to 10 MHz: <-50 dBc ≥10 MHz to 25 MHz: <-40 dBc	10 Hz to 1 MHz: <-60 dBc ≥1 MHz to 5 MHz: <-50 dBc ≥5 MHz to 100 MHz: <-37 dBc	10 Hz to 1 MHz: <-60 dBc ≥1 MHz to 5 MHz: <-50 dBc ≥5 MHz to 25 MHz: <-37 dBc ≥25 MHz to 240 MHz: <-30 dBc
✓Total Harmonic Distortion (at 1 V _{p-p} amplitude)	10 Hz to 20 kHz: <0.2%		
✓Spurious ¹ (nonharmonic) (at 1 V _{p-p} amplitude)	10 Hz to 1 MHz: <-60 dBc ≥1 MHz to 25 MHz: <-50 dBc	10 Hz to 1 MHz: <-60 dBc ≥1 MHz to 25 MHz: <-50 dBc ≥25 MHz to 100 MHz: -50 dBc + 6 dBc/oct	10 Hz to 1 MHz: <-50 dBc ≥1 MHz to 25 MHz: <-47 dBc ≥25 MHz to 240 MHz: -47 dBc + 6 dBc/oct
Phase Noise, typical (at 1 V _{p-p} amplitude)	20 MHz: <-110 dBc/Hz at 10 kHz offset		
Residual Clock Noise, typical	-63 dBm	-57 dBm	-57 dBm
Square Wave	AFG3021B/AFG3022B	AFG3101/AFG3102	AFG3251/AFG3252
✓Rise Time/Fall Time	≤ 18 ns	≤ 5 ns	≤ 2.5 ns
Jitter (rms), typical	500 ps	200 ps	100 ps
Pulse	AFG3021B/AFG3022B	AFG3101/AFG3102	AFG3251/AFG3252
Pulse Width	30 ns to 999.99 s	8 ns to 999.99 s	4 ns to 999.99 s
Resolution	10 ps or 5 digits		
Pulse Duty	0.001% to 99.999%		
Leading Edge/Trailing Edge	18 ns to 0.625 * Pulse Period	5 ns to 0.625 * Pulse Period	2.5 ns to 0.625 * Pulse Period
Resolution	10 ps or 4 digits		
Overshoot, typical	<5%		
Jitter (rms), typical	500 ps	200 ps	100 ps

Output Characteristics (cont.)

Ramp	AFG3021B/AFG3022B	AFG3101/AFG3102	AFG3251/AFG3252
Linearity ² , typical	≤ 0.1% of peak output	≤ 0.15% of peak output	≤ 0.2% of peak output
Symmetry	0% to 100.0%		
Noise	AFG3021B/AFG3022B	AFG3101/AFG3102	AFG3251/AFG3252
Bandwidth, typical	25 MHz	100 MHz	240 MHz
Arbitrary	AFG3021B/AFG3022B	AFG3101/AFG3102	AFG3251/AFG3252
Rise Time/Fall Time, typical	≤ 20 ns	≤ 8 ns	≤ 3 ns
Jitter (rms), typical	4 ns	1 ns at 1 GS/s 4 ns at 250 MS/s	500 ps at 2 GS/s 4 ns at 250 MS/s

1. Exclude harmonics and channel crosstalk.
2. Frequency: 1 kHz, Amplitude: 1 V_{p-p}, Symmetry: 100%
10% to 90% of amplitude range

Modulation

AM (Amplitude Modulation)			
Carrier Waveforms	Standard waveforms (except Pulse, DC, and Noise) and Arb		
Modulation Source	Internal or External		
Internal Modulating Waveforms	Sine, Square, Ramp, Noise, and Arb ¹		
Internal Modulating Frequency	2 mHz to 50.00 kHz		
Depth	0.0% to 120.0%		
FM (Frequency Modulation)	AFG3021B/AFG3022B	AFG3101/AFG3102	AFG3251/AFG3252
Carrier Waveforms	Standard waveforms (except Pulse, DC, and Noise) and Arb		
Modulation Source	Internal or External		
Internal Modulating Waveforms	Sine, Square, Ramp, Noise, and Arb ²		
Internal Modulating Frequency	2 mHz to 50.00 kHz		
Peak Deviation	DC to 12.5 MHz	DC to 50 MHz	DC to 120 MHz
PM (Phase Modulation)			
Carrier Waveforms	Standard waveforms (except Pulse, DC, and Noise) and Arb		
Modulation Source	Internal or External		
Internal Modulating Waveforms	Sine, Square, Ramp, Noise, and Arb ²		
Internal Modulating Frequency	2 mHz to 50.00 kHz		
Phase Deviation Range	0.0 to 180.0 degrees		

Modulation (cont.)

FSK (Frequency Shift Keying)			
Carrier Waveforms	Standard waveforms (except Pulse, DC, and Noise) and Arb		
Modulation Source	Internal or External		
Internal Key Rate	2 mHz to 1.000 MHz		
Numbers of Key	2		
PWM (Pulse Width Modulation)			
Carrier Waveforms	Pulse		
Modulation Source	Internal or External		
Internal Modulating Waveforms	Sine, Square, Ramp, Noise, and Arb ²		
Internal Modulating Frequency	2 mHz to 50.00 kHz		
Deviation Range	0.0% to 50.0% of pulse period		
Sweep	AFG3021B/AFG3022B	AFG3101/AFG3102	AFG3251/AFG3252
Type	Linear or Logarithmic		
Start/Stop Frequency ³ (except Arb)	1 μ Hz to 25 MHz	1 μ Hz to 100 MHz	1 μ Hz to 240 MHz
Start/Stop Frequency (Arb)	1 mHz to 25 MHz	1 mHz to 100 MHz	1 mHz to 240 MHz
Sweep/Hold/Return Time ⁴	Range: 1 ms to 300 s (Sweep time) 0 ms to 300 s (Hold/Return time) Resolution: 1 ms or 4 digits		
Total Sweep Time Accuracy, typical	$\leq 0.4\%$		

1. The maximum waveform length for Arb is 4,096. Waveform data points over 4,096 are ignored.
2. The maximum waveform length for Arb is 2,048. Waveform data points over 2,048 are ignored.
3. Pulse, DC, and Noise waveforms are not available.
4. Total sweep time = Sweep time + Hold time + Return time ≤ 300 s

Inputs/Outputs

Front Panel

CH1 Trigger Output	
Level	Positive TTL level pulse into 1 k Ω
Impedance	50 Ω
Jitter (rms), typical	500 ps (AFG3021B/AFG3022B) 200 ps (AFG3101/AFG3102) 100 ps (AFG3251/AFG3252)
Trigger Input	
Level	TTL compatible
Pulse Width	100 ns minimum
Impedance	10 k Ω
Slope	Positive/Negative, selectable
Trigger Delay	0.0 ns to 85.000 s Resolution: 100 ps or 5 digits
Jitter (rms), typical	Burst: <500 ps (Trigger input to signal output)

Rear Panel

External Modulation Input	
Input Range	± 1.0 V full scale (except FSK) 3.3 V logic level (FSK)
Impedance	10 k Ω
Frequency Range	AM, FM, PM, FSK, PWM: DC to 25 kHz (122 KS/s)
External Reference Output (AFG3101/AFG3102 and AFG3251/AFG3252)	
Impedance	50 Ω , AC coupled
Amplitude	1.2 V _{p-p} into 50 Ω
External Reference Input	
Impedance	1 k Ω , AC coupled
Required Input Voltage Swing	100 mV _{p-p} to 5 V _{p-p}
Lock Range	10 MHz \pm 35 kHz
CH1 Additional Input (AFG3101/AFG3102 and AFG3251/AFG3252)	
Impedance	50 Ω
Input Range	-1 V to +1 V (DC + peak AC)
Bandwidth	DC to 10 MHz (-3 dB) at 1 V _{p-p}

General

System Characteristics

Warm-up Time, typical	20 minutes minimum		
Power On Self Calibration, typical	<16 s		
Configuration Times, typical	USB	LAN	GPIB
Function Change	95 ms	103 ms	84 ms
Frequency Change	2 ms	19 ms	2 ms
Amplitude Change	60 ms	67 ms	52 ms
Select User Arb	88 ms	120 ms	100 ms
Data Download, typical	4000 points waveform data GPIB: 42 ms USB: 20 ms LAN: 84 ms		
Acoustic Noise, typical	<50 dBA		
Weight (approximate)	4.5 kg		

Power

Source Voltage and Frequency	100 V to 240 V, 47 Hz to 63 Hz 115 V, 360 Hz to 440 Hz
Power Consumption	Less than 120 W

Environmental, EMC, Safety

Temperature Range	
Operating	0 °C to +50 °C
Nonoperating	-30 °C to +70 °C
Humidity	
Operating	At or below +40 °C: ≤ 80% >+40 °C to +50 °C: ≤ 60%
Altitude	
Operating	Up to 3,000 meters (10,000 feet)
EMC Compliance	
European Union	EN 61326 Class A ^{1, 2} EN 61000-3-2, and EN 61000-3-3 IEC 61000-4-2, 4-3, 4-4, 4-5, 4-6, 4-11
Australia	AS/NZS 2064
Safety	UL 61010-1:2004 CAN/CSA C22.2 No. 61010-1:2004 IEC 61010-1:2001

1. Emissions that exceed the levels required by this standard may occur when this equipment is connected to a test object.
2. To ensure compliance to the standards listed above, attach only high quality shielded cables to this instrument. High quality shielded cables typically are braid and foil types that have low impedance connection to shielded connectors at both ends.

Instrument Dimensions

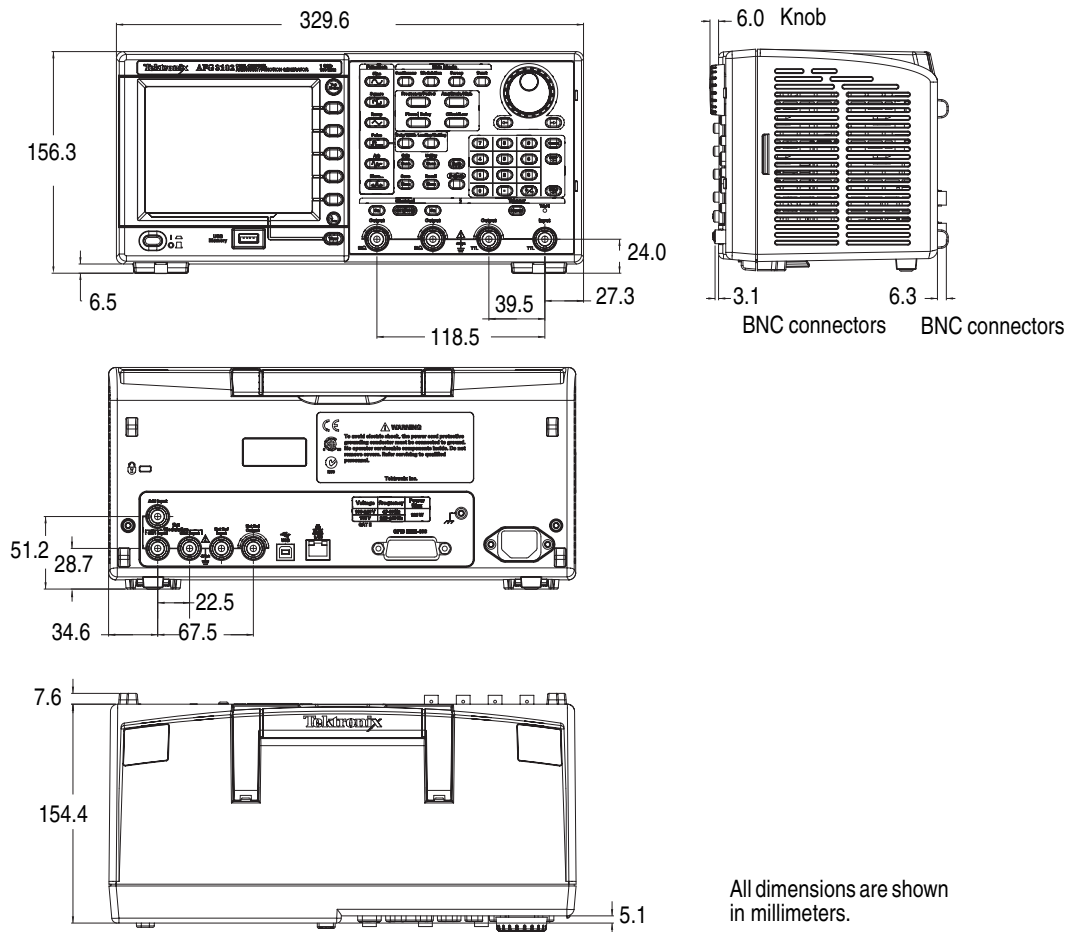

All dimensions are shown in millimeters.

Dimensions of the RM3100 Rackmount

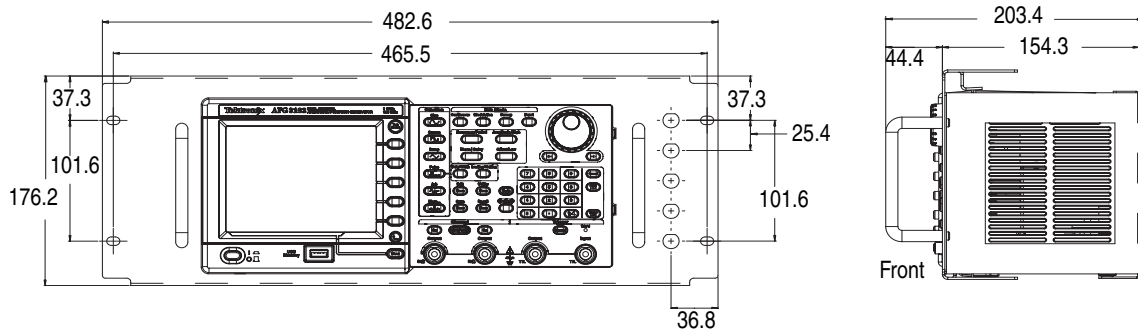

RM3100 conforms to EIA-310-D specification.
Weight (without AFG3000 series): 2.1 kg

Index

A

- Access Protection 65
 - Firmware update 15
- Accessing Help 4
- ADD INPUT connector
 - Add signal 57
 - Rear panel 34
- Add Noise 56
- Add Signal 57
- Adjusting parameters of two channel signal
 - Amplitude 53
 - Frequency 53
 - Period 53
 - Phase 52
- Align Phase 52
- Amplitude, To change the units 32
- Application examples
 - Frequency modulation 76
 - Lissajous patterns 73
 - Pulse-width modulation 75
 - Sweep 74
- Arb button (front panel)
 - Recalling arbitrary waveforms 36
- ArbExpress vii, 67
 - Basic operations 69
 - Screen interface 68
 - System requirements 67
- Arbitrary waveforms
 - Save and recall 36

B

- Beeper, Utility menu 62
- Bezel menu buttons 23
- Bezel menu, Screen interface 24

C

- Carrier null, Application examples 76
- Center frequency, Sweep waveform 44
- Changing the password,
 - Security menu 66
- Chassis ground screw, Rear panel 34
- Click tone, Utility menu 62

- Connect to a network
 - Ethernet 18
 - GPIB 19
 - USB interface 18
- CSV file, ArbExpress 71

D

- DC, Standard waveform 29
- Default button 9
- Default setup 27
- Default, Power on settings 9
- Differential signal 55
- Documentation vii
- Double pulse,
 - Generate a burst waveform 42

E

- Edit menu 38
 - Recalling waveform data 38
 - Saving waveform data 38
- Environmental requirements 6
- Equation Editor, ArbExpress 69
- Equivalent output circuits 21
- Erase
 - Arbitrary waveform data 36
 - Instrument setups 64
- Exponential Decay,
 - Standard waveform 29
- Exponential Rise, Standard waveform 29
- EXT MODULATION INPUT connector,
 - Rear panel 34
- EXT REF INPUT connector,
 - Rear panel 34
- EXT REF OUTPUT connector,
 - Rear panel 34
- External reference clock, Rear panel 58

F

- Firmware updates 15
- Floating ground 13
- Frequency span, Sweep waveform 44
- Front panel 23

- Front panel controls
 - How to lock or unlock 23
- Function buttons 23
- Fuse adapter, Protect output circuits 12

G

- Gaussian, Standard waveform 29
- General features 5
- Generate a burst waveform 42
- Generate a gated waveform 43
- Generate a pulse waveform 35
- Generate a sine waveform 2
- Generate an arbitrary waveform 37
- Generate DC 41
- Generate Noise 41
- GPIB connector, Rear panel 34

H

- Haversine, Standard waveform 29
- Help 4
- Hold time, Sweep waveform 44

I

- Instrument dimensions 84
- Instrument power-on and power-off 8
- Instrument settings when powered-on 9
- Invert waveform polarity 55

L

- LAN connector, Rear panel 34
- Last, Power on settings 9
- Level meter, Screen interface 24
- Lissajous Patterns,
 - Application examples 73
- Load impedance 21, 54
- Lock front panel controls 23
- Lock/unlock
 - Arbitrary waveform data 36
 - Instrument setups 64
- Lorentz, Standard waveform 29

M

Main display area, Screen interface 24
 Master-slave operation 59
 Measurement of filter characteristics,
 Application examples 74
 Menu buttons 23
 Message display area,
 Screen interface 24
 Modify an arbitrary waveform 38
 Modulate a waveform 46

N

Noise, Standard waveform 29
 Number of Points, Edit menu 28

O

Operating requirements 6
 Option buttons 24
 Output menu
 To add Noise 56
 To add signal 57
 To invert waveform 55
 To protect your DUT 14
 To set up load impedance 54
 Output On/Off 33
 Output status
 Noise 56
 Screen interface 24
 Output window 21

P

Performance test vii
 Phase | Delay shortcut button 26
 Power button 8
 Power consumption 6
 Power off 8
 Power on 8
 Power supply requirements 6
 Power switch 23
 Procedure
 To adjust waveform parameters 31
 To connect to a network 18
 To generate a pulse waveform 35
 To generate a sine waveform 2

 To generate an arbitrary waveform 37
 To modify an arbitrary waveform 38
 To output a PWM waveform 49
 To output an AM waveform 46
 To output an FSK waveform 48
 To restore the default setup 27
 To select a channel 33
 To select a local language 11
 To select a waveform 28
 To select Run Mode 30
 To sweep a waveform 44
 Programming information vii
 Protect output circuits, Fuse adapter 12
 Protect your DUT 14
 Pulse-width modulation,
 Application examples 75

Q

Quick Tutorial 1

R

Rackmount, dimensions 84
 Rear panel 34
 Recommended accessories 8
 Reference Manual vii, 20, 27
 Reference signal, Internal or External 58
 Related documentation vii
 Remote control, ArbExpress 70
 Return time, Sweep waveform 44
 Run Mode 30

S

Save/Recall instrument setup 64
 Screen interface 24
 Screen saver, Utility menu 62
 Screen view formats 25
 Secure function, Utility menu 9, 62
 Security menu 65
 Firmware update 17
 Security slot, Rear panel 34
 Selecting a local language 11
 Self calibration 10
 Self test, Utility menu 10
 Service Manual vii

Set up load impedance 54
 Shortcut buttons 23, 26
 Side-menu buttons 24
 Sin(x)/x, Standard waveform 29
 Soft keys 24
 Specifications 77
 Standard accessories 7
 Standard Waveform dialog box,
 ArbExpress 69
 Standard waveforms 28
 Start frequency, Sweep waveform 44
 Stop frequency, Sweep waveform 44
 Sweep time, Sweep waveform 44
 Sweep waveform,
 Application examples 74
 Synchronous operation 59

T

TFS file, Saving instrument setup 64
 TFW file
 ArbExpress 67, 71
 Saving arbitrary waveform 36
 Top Menu button 23
 Trigger input connector 23
 Trigger out 50
 Trigger output connector 23, 50

U

Unlock front panel controls 23
 USB connector
 Front panel 23
 Rear panel 34
 USB memory 61
 Firmware updates 15
 Save/Recall arbitrary waveform 36
 Save/Recall instrument setup 64
 To generate an arbitrary waveform 37
 Utility menu 62
 Access protection 65
 Connecting to a network 18
 Language selection 11
 Self test and self calibration 10
 Synchronous operation 59
 Updating instrument firmware 15

V

View button 23, 25, 40

View tab, Screen interface 24

Voltage units, Conversion table of Vp-p,
Vrms, and dBm 32

W

Waveform Math dialog box,
ArbExpress 70

Waveform parameter,
how to change 31

